



**Geethanjali**  
College of Engineering and Technology  
*...Striving Towards Perfection*

Approved by AICTE and Affiliated to JNTUH

# **SURVEYING LAB - II MANUAL**

## **CONTENTS**

<b>SI No</b>	<b>List of Experiments</b>
1.	Study of theodolite in detail - practice for measurement of horizontal and vertical angles.
2.	Measurement of horizontal angles by method of repetition and reiteration.
3.	Trigonometric Leveling - Heights and distance problem (Two Exercises)
4.	Heights and distance using Principles of tacheometric surveying (Two Exercises)
5.	Curve setting – different methods. (Two Exercises)
6.	Determine of area using total station.
7.	Traversing using total station.
8.	Contouring using total station.
9.	Determination of remote height using total station.
10.	Stake out using total station.
11.	Distance , gradient ,diff, height between two inaccessible points using total station.

## STUDY OF THEODOLITE

### OBJECTIVE:

To study different parts of transit Theodolite and Temporary adjustments.



### DEFINITION AND TERMS

#### VERTICAL AXIS:

It is the axis about which the telescope can be rotated in a horizontal plane.

#### HORIZONTAL AXIS:

It is the axis about which the telescope can be rotated in a vertical plane.

#### LINE OF COLLIMATION:

It is the imaginary line joining the intersection of the cross hairs of the diaphragm to the optical center of the object glass and its continuation.

#### AXIS OF THE TELESCOPE:

It is the line joining the optical center of the object glass to the center of the eye-piece.

#### AXIS OF THE LEVEL TUBE:

It is the straight line tangential to the longitudinal curve of the level tube at the center of the tube.

---

**CENTERING:**

The process of setting the theodolite exactly over the station mark is known as centering.

**TRANSITING:**

It is the process of turning the telescope in vertical plane through  $180^\circ$  about the trunnion axis.

**DESCRIPTION OF EQUIPMENT:****TELESCOPE:**

It consists of eye-piece, object glass and focusing screw and it is used to sight the object.

**VERTICAL CIRCLE:**

It is used to measure vertical angles.

**LEVELLING HEAD:**

It consists of two parallel triangular plates called tribrach plates. Its uses are

1. To support the main part of the instrument.
2. To attach the theodolite to the tripod.

**LOWER PLATE:**

It consists of lower clamp screw and tangent screw.

**UPPER PLATE:**

The upper plate is attached to the inner axis and it carries two verniers. It consists an upper clamp screw and tangent screws. These screws are used to fix upper plate with lower plate accurately.

**FOOT SCREWS:**

These are used to level the instrument

**PLUMB BOB:**

It is used to center theodolite exactly over the ground station mark.

**SWINGING THE TELESCOPE:**

It means turning the telescope about its vertical axis in the horizontal plane. A swing is called right or left according as the telescope is rotated clockwise or counter clockwise.

**FACE LEFT:**

If face of the vertical circle is to the left side of the observer, then the observation of the angles taken is known as face left observation.

**FACE RIGHT:**

If the face of the vertical circle is to the right side of the observation, then the observation of the angles taken is known as face right observation.

**CHANGING FACE:**

It is an operation of bringing the face of the telescope from left to right and vice-versa.

**TEMPORARY ADJUSTMENTS:**

---

There are three temporary adjustments of a theodolite. These are

1. Setting up the theodolite over a station.
2. Leveling up.
3. Elimination of parallax.

#### **SETTING UP:**

It includes two operations

1. Centering a theodolite over a station: Done by means of plumb bob.
2. Approximately leveling it by tripod legs only: Done by moving tripod legs radially or circumferentially.

#### **LEVELING UP:**

Having centered and approximately leveled the instrument, accurate leveling is done with the help of foot screws with reference to the plate levels, so that the vertical axis shall be truly vertical.

To level the instrument the following operations have to be done.

1. Turn the upper plate until the longitudinal axis of the plate level is roughly parallel to a line joining any two of the leveling screws (A & B).

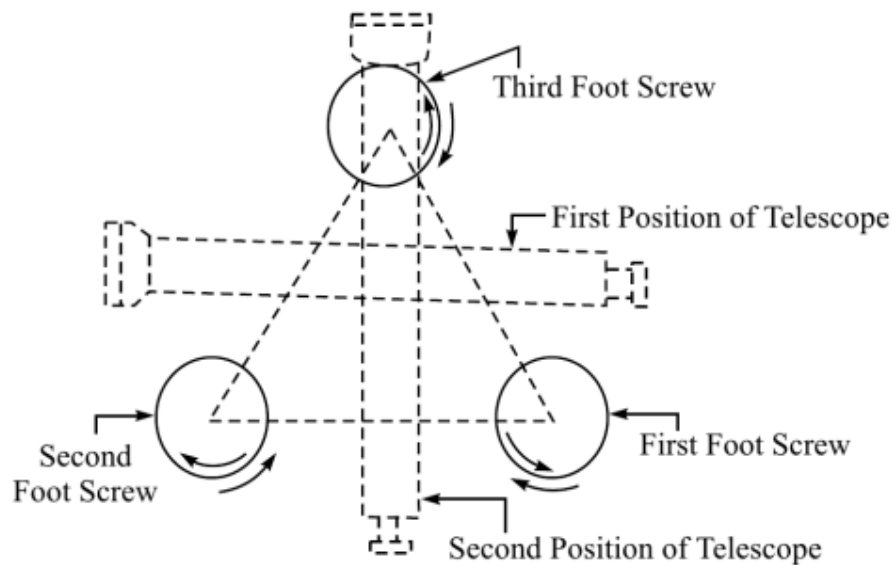

#### **Levelling of Foot Screws**

2. Hold these two leveling screws between the thumb and first finger of each hand uniformly so that the thumb moves either towards each other or away from each other until the bubble comes to the center.
  3. Turn the upper plate through  $90^\circ$  i.e until the axes of the level passes over the position of the third leveling screw 'C'.
  4. Turn this leveling screw until the bubble comes to the center.
-

5. Rotate the upper plate through  $90^\circ$  to its original position fig(a) and repeat step(2) till the bubble comes to the center.
6. Turn back again through  $90^\circ$  and repeat step 4.
7. Repeat the steps 2 and 4 till the bubble is central in both the positions.
8. Now rotate the instrument through  $180^\circ$ . The bubble should be remaining in the center of its run, provided it is in correct adjustment. The vertical axis will then be truly vertical.

### 3. ELIMINATION OF PARALLAX:

Parallax is a condition arising when the image formed by the objective is not in the plane of the cross hairs. Unless parallax is eliminated, accurate sighting is not possible. Parallax can be eliminated in two steps.

#### a. FOCUSING THE EYE-PIECE:

Point the telescope to the sky or hold a piece of white paper in front of the telescope. Move the eyepiece in and out until a distant and sharp black image of the cross-hairs is seen.

#### b. FOCUSING THE OBJECT:

Telescope is now turned towards object to be sighted and the focusing screw is turned until image appears clear and sharp.

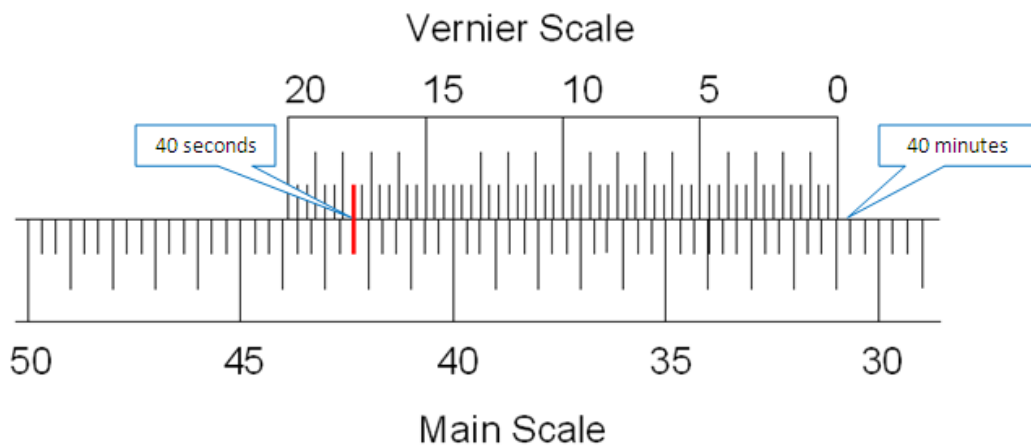

	°	'	''
Main Scale	30	40	
Vernier Scale		17	40
<b>Reading</b>	<b>30</b>	<b>57</b>	<b>40</b>

## MEASUREMENT OF HORIZONTAL ANGLE BY REPETITION METHOD

### OBJECTIVE:

To measure a horizontal angle by repetition method.

**THEORY:** In this method, the angle is added several times mechanically and the value of the angle obtained by dividing the accumulated reading by the number of repetitions.

### EQUIPMENTS USED:

- Transit Theodolite
- Tripod and
- Ranging rods

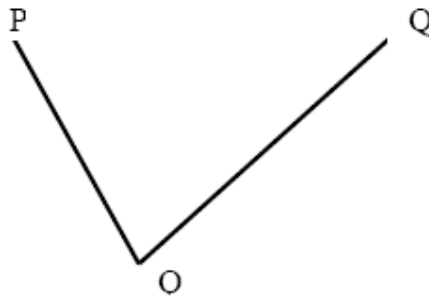

### PROCEDURE:

1. Set up the instrument over 'O' and level it accurately.
  2. With the help of upper clamp and tangent screw, set  $0^{\circ}$  reading on vernier 'A'. Note the reading of vernier 'B'.
  3. Release the upper clamp and direct the telescope approximately towards the point 'P'. Tighten the lower clamp and bisect point 'P' accurately by lower tangent screw.
  4. Release the upper clamp and turn the instrument clock-wise towards Q. Clamp the upper clamp and bisect 'Q' accurately with the upper tangent screw. Note the readings of verniers 'A' and 'B' to get the values of the angle POQ.
  5. Release the lower clamp and turn the telescope clockwise to sight P again. Bisect P by using the lower tangent screw.
  6. Release the upper clamp, turn the telescope clockwise and sight Q. Bisect Q by using the upper tangent screw.
-

7. Repeat the process until the angle measured (required number of times is 3). The average angle with face left will be equal to final reading divided by three.
  8. Change face and make three more repetitions as described above. Find the average angle with face right, by dividing the final reading by three.
  9. The average horizontal angle is then obtained by taking the average of the two angles with face left and face right.
-



## MEASUREMENT OF HORIZONTAL ANGLE BY REITERATION METHOD

### OBJECTIVE:

To measure horizontal angle by reiteration method.

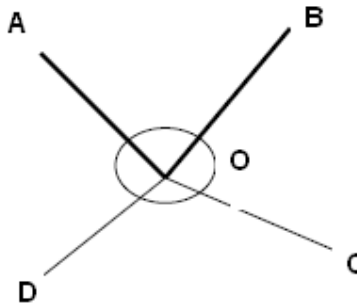

### EQUIPMENTS:

- Transit Theodolite
- Tripod and
- Ranging rods

### PROCEDURE:

If it is required to measure angles AOB, BOC, and COD etc by reiteration method

The following steps are to be used.

1. Set the instrument over "O" and level it set the Vernier to zero and bisect point A accurately.
  2. Loose the upper clamp and turn the Telescope clockwise to point B. Bisect B by using the upper tangent screw. Read both the Verniers, the mean of the Verniers will give the angles AOB.
  3. Similarly, bisect successively C, D etc, thus closing the circle. Read both the Verniers at each bisection.
  4. Finally sight to A the reading of the vernier should be the same as the original setting reading.
- Repeat the steps 02 to 04 with other face i.e. face Right.

## DETERMINING AN HEIGHT OF OBJECT BY MEASURING VERTICAL ANGLE

### OBJECTIVE:

Determining a height of object by measuring vertical angle.

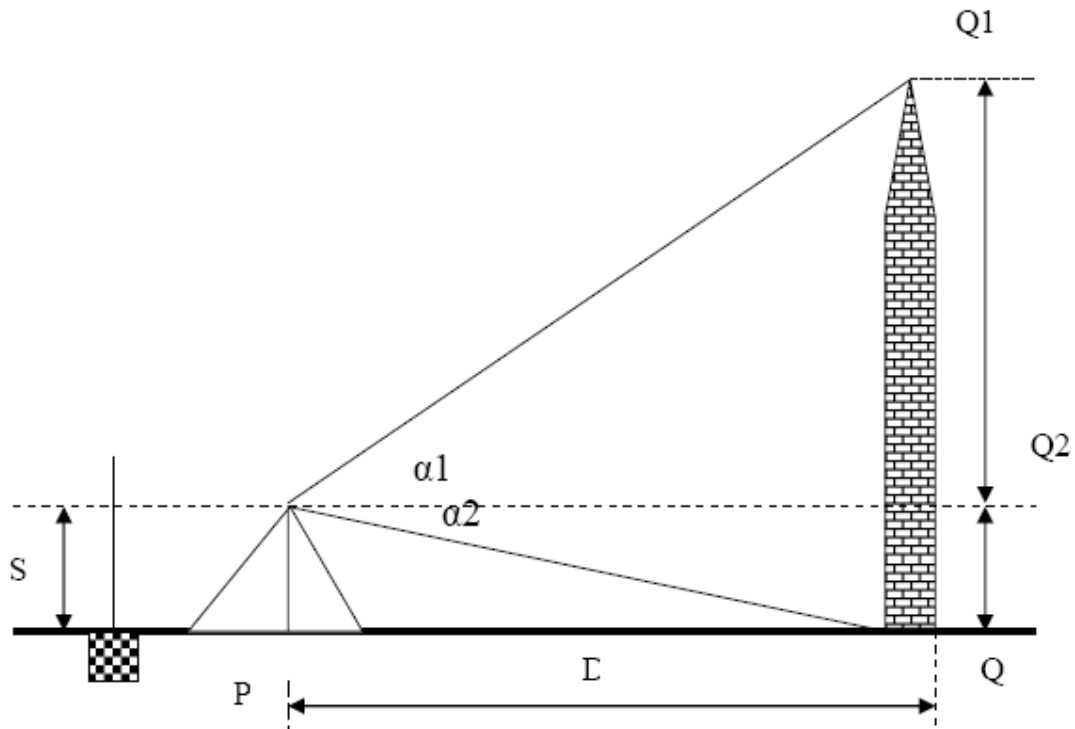

### EQUIPMENTS:

1. Theodolite
2. Leveling Stop
3. Tape or Chain
4. Pegs
5. Plumb bob

### PROCEDURE:

1. Setup the instrument at station P.
  2. Perform all temporary adjustments.
  3. Bring the line of collimation horizontal
  4. Enter the initial readings in the tabular form.
  5. Swing the telescope and take staff reading over the given B.M.
  6. Swing the telescope towards the object.
-

7. Release the vertical clamp screw, sight the top of the object Q1, and clamp the vertical clamp screw.
8. Read C and D verniers and enter the readings.
9. Release the vertical clamp screw, sight the bottom of the object Q, and clamp the screw.
10. Read vernier readings and enter in the tabular form.
11. Measure the Horizontal distance between the instrument station and the object.
12. The above procedure will be repeated with the face right observation.
13. The average of the two observations by transiting the telescope taken with different faces will be vertical angle.
14. Calculate the height of the top point Q1 from horizontal line (h1) and height of the bottom point Q0 from horizontal line (h2) by using formula  $h = d \tan \alpha$

**Methods:**

1. Measurement of Height of an object when base is accessible (on level ground)

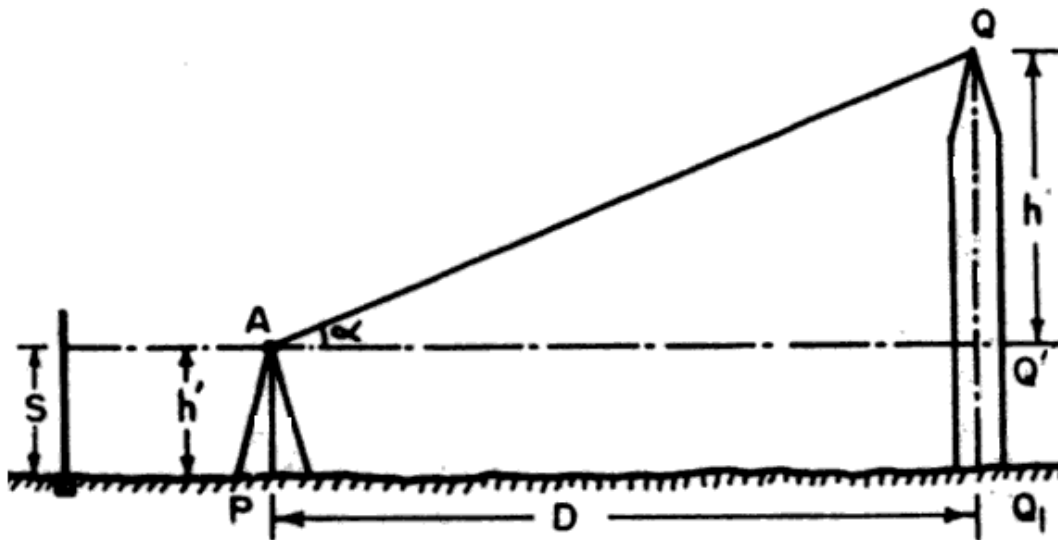

**BASE ACCESSIBLE.**

$$h = D \tan \alpha$$

$$\text{Height of the object} = s + h$$

$$\text{R.L. of top of the object} = \text{R. L. of B.M.} + s + h$$

2. Measurement of Height of an object when base is inaccessible

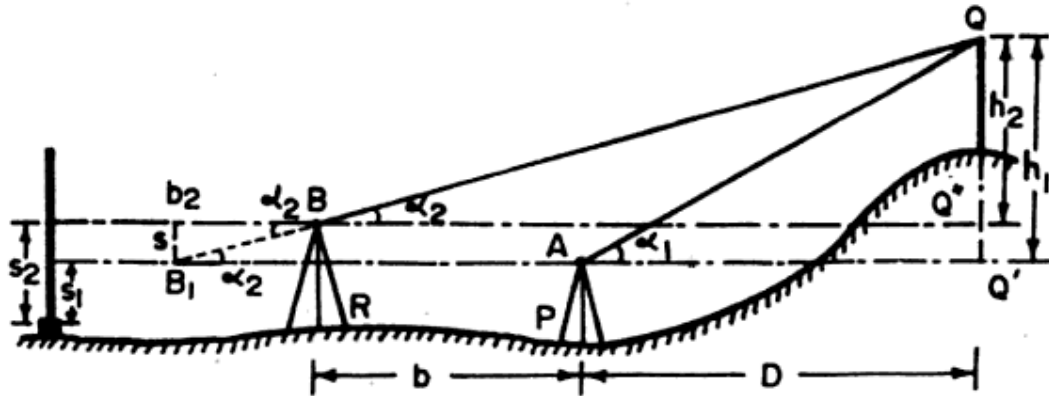

When P is Lower than R

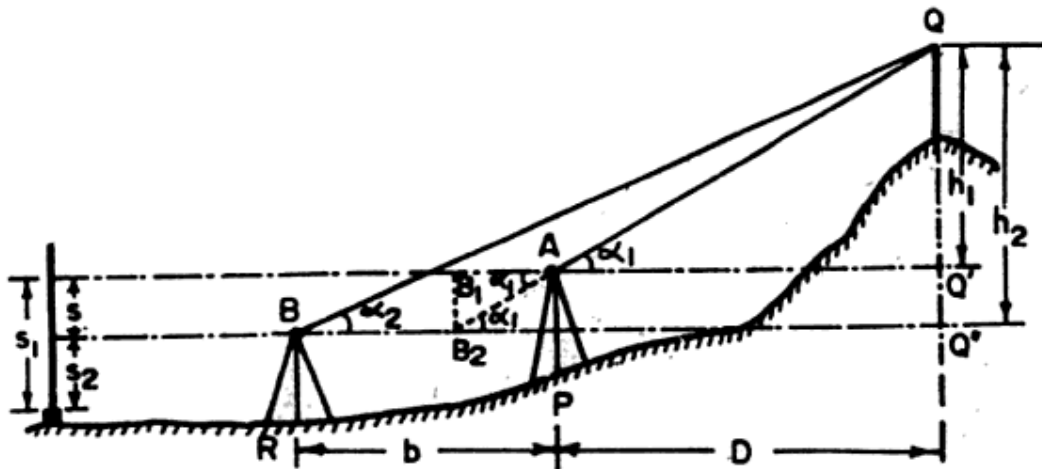

When P is higher than R

$$D = \frac{(b \pm s \cot \alpha_2) \tan \alpha_2}{\tan \alpha_1 - \tan \alpha_2}$$

Use + sign with  $s \cot \alpha_2$  when the instrument axis at A is lower and - sign when it is higher than at B.

$$\text{R.L. of } Q = \text{R.L. of B.M.} + S_1 + h_1$$

$$h_1 = D \tan \alpha_1$$

## DETERMINATION OF CONSTANTS OF TACHEOMETER

### OBJECTIVE

To determine the multiplying constant and additive constant of the given theodolite.

### EQUIPMENTS

- Theodolite
- Ranging Rods
- Levelling Staff
- Tape

### PROCEDURE

1. Stretch the chain in the field and drive pegs at 10m, 20m interval.
2. Set the theodolite at the zero and do the temporary adjustments.
3. Keep the staff on the pegs and observe the corresponding staff intercepts with horizontal site.
4. Substitute the values of distance (D) and staff intercept (s) for different points in the equation  $D = ks + C$ , where k & s are the tacheometric constants. k is the multiplying constant & C is the additive constant.
5. Solve the successive pairs of equations to get the value of k & C and find out the average of these values.

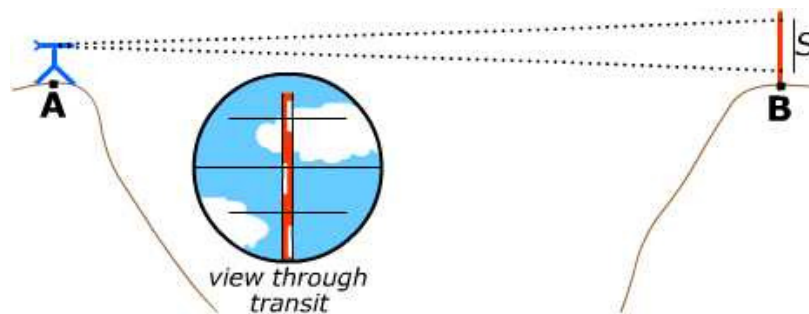

## Measurement of Horizontal Distance

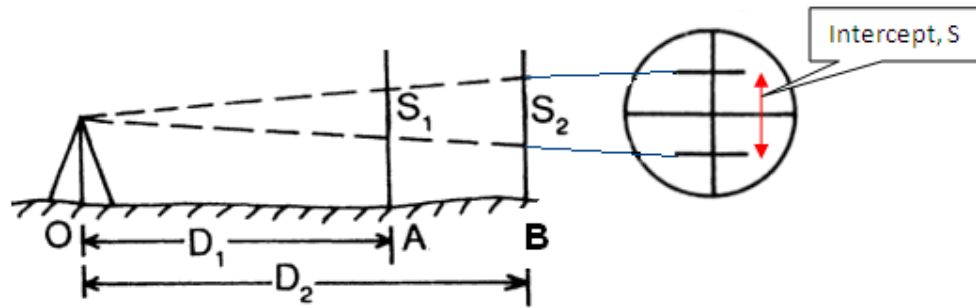

Instrument Station	Staff Station	Distance	Stadia Reading			Stadia Intercept (S)
			Top	Middle	Bottom	
O	A					
	B					

$$D = KS + C$$

$$D_1 = K.S_1 + C \rightarrow 1$$

$$D_2 = K.S_2 + C \rightarrow 2$$

Solve Two Equations & find K & C

### RESULT:

Multiplying constant, K =

Additive constant, S =

## MEASUREMENT OF HORIZONTAL DISTANCE & VERTICAL HEIGHTS USING TACHEOMETRIC SURVEYING

### OBJECTIVE:

Determination of elevation of points by Tacheometric surveying

### EQUIPMENT:

- Tacheometer with tripod,
- Tape,
- Leveling staff,
- Ranging rods

### THEORY:

The Tacheometer is an instrument which is generally used to determine the horizontal as well as vertical distance . it can also be used to determine the elevation of various points which cannot be determine by ordinary leveling. When one of the sight is horizontal and staff held vertical then the RLs of staff station can be determined as we determine in ordinary leveling .But if the staff station is below or above the line of collimation then the elevation or depression of such point can be determined by calculating vertical distances from instrument axis to the central hair reading and taking the angle of elevation or depression made by line of sight to the instrument made by line of sight to the instrument axis.

### Procedure:

- 1) Set up the instrument in such a way that all the point should be visible from the instrument station.
  - 2) Carryout the temporary adjustment and set vernier zero reading making line of sight horizontal.
  - 3) Take the first staff reading on Benchmark and determine height of instrument.
  - 4) Then sight the telescope towards the staff station whose R.Ls are to be calculated. Measure the angle on vernier if line of sight is inclined upward or downward and also note the three crosshair readings.
  - 5) Determine the R.Ls of various points by calculating the vertical distance
-

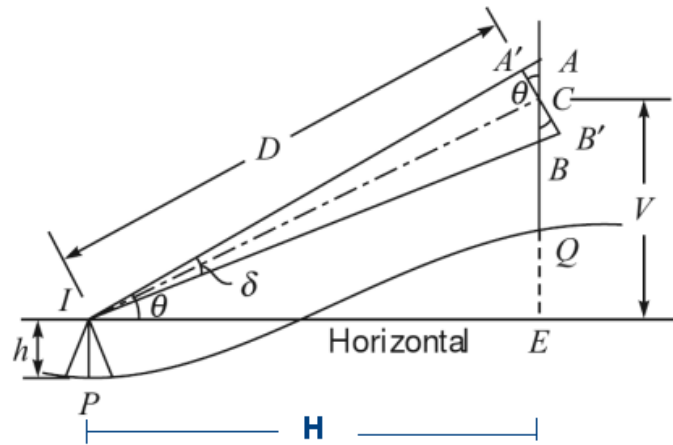

Inclined sight (elevation)

$$H = D \cos \theta = KS \cos^2 \theta + C \cos \theta$$

$$V = \frac{1}{2} KS \sin 2\theta + C \sin \theta$$

$$\text{R.L. of } Q = \text{R.L. of } P + h + V - CQ$$

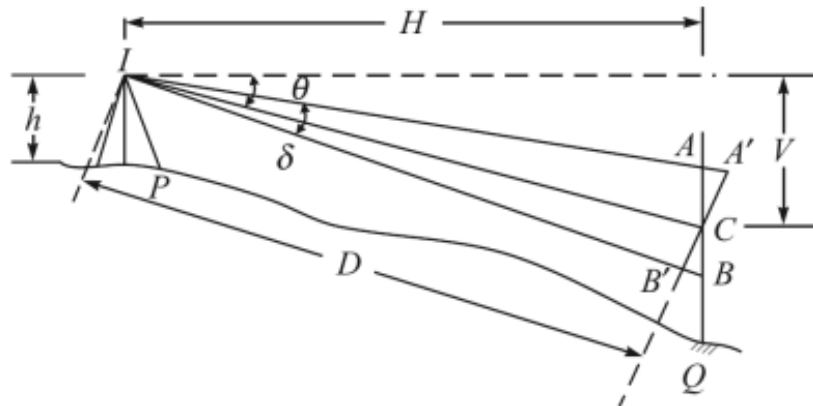

Inclined sight (depression).

$$D = KS \cos \theta + C$$

$$H = D \cos \theta = KS \cos^2 \theta + C \cos \theta$$

$$V = D \sin \theta = KS \sin \theta \cos \theta + C \sin \theta$$

$$\text{R.L. of } Q = \text{R.L. of } P + h - V - CQ$$



## SIMPLE CURVE SETTING BY OFFSETS FROM LONG CHORD METHOD

### OBJECTIVE:

To set out a simple curve by linear method (offsets from long chord method)

### EQUIPMENT:

- Cross Staff,
- Arrows,
- Ranging rod
- Tape

### THEORY:

Linear methods are used when:-

1. High degree of accuracy is not required
2. The curve is short

Linear methods for setting out curve include

1. **By ordinates or offsets from long chord.**
2. By offsets from tangents (T)
  - a. Perpendicular offsets
  - b. Radial offsets

### ELEMENTS OF SIMPLE CIRCULAR CURVE

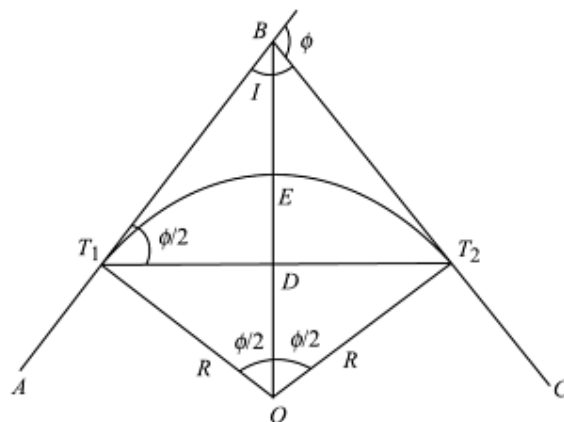
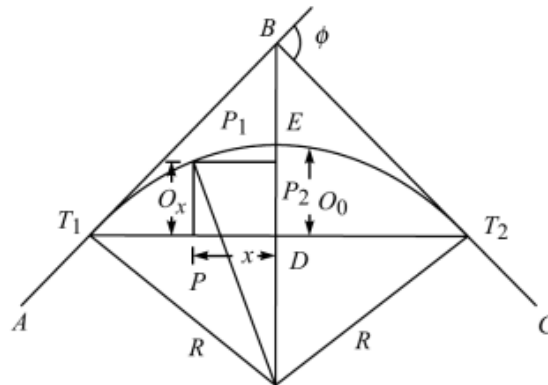

**Fig. 10.10** Notations for Circular Curves

1.  $AB$  and  $BC$  are known as the *tangents* to the curve (Fig. 10.10).
2.  $B$  is known as the *point of intersection* or *vertex*.
3. The angle  $\phi$  is known as the *angle of deflection*.
4. The angle  $I$  is called the *angle of intersection*.
5. Points  $T_1$  and  $T_2$  are known as *tangent points*.
6. Distances  $BT_1$  and  $BT_2$  are known as *tangent lengths*.
7. When the curve deflects to the right, it is called a *right-hand curve*, when it deflects to the left, it is said to be a *left-hand curve*.
8.  $AB$  is called the *rear tangent* and  $BC$ , the *forward tangent*.
9. The straight line  $T_1DT_2$  is known as the *long chord*.
10. The curved line  $T_1ET_2$  is said to be the *length of the curve*.
11. The mid-point  $E$  of the curve  $T_1ET_2$  is known as the *apex* or *summit of the curve*.
12. The distance  $BE$  is known as the *apex distance* or *external distance*.
13. The distance  $DE$  is called the *versed sine* of the curve.
14.  $R$  is the *radius* of the curve.

### Offsets or Ordinates from a Long Chord

Let  $AB$  and  $BC$  be two tangents meeting at a point  $B$ , with a deflection angle  $\phi$ . The following data are calculated for setting out the curve (Fig. 10.11).



**Fig. 10.11** Offsets from a Long Chord

1. The tangent length is calculated according to the formula;  $TL = R \tan \phi/2$
2. Tangent points  $T_1$  and  $T_2$  are marked.
3. The length of the curve is calculated according to the formula:

$$CL = \frac{\pi R \phi^\circ}{180^\circ}$$

4. The chainages of  $T_1$  and  $T_2$  are found out.
5. The length of the long chord ( $L$ ) is calculated from

$$L = 2R \sin \phi/2$$

6. The long chord is divided into two equal halves, the left half and the right half. Here the curve is symmetrical in both the halves.
7. The mid-ordinate  $O_0$  is calculated as follows:

$$(a) O_0 = DE = \text{versed sine of curve} = R(1 - \cos \phi/2) \quad (10.3)$$

$$(b) \text{ Again, } OF = R \text{ and } OD = R - O_0$$

$$\text{From triangle } OT_1D, \quad OT_1^2 = OD^2 + T_1D^2$$

$$\text{or} \quad R^2 = (R - O_0)^2 + \left(\frac{L}{2}\right)^2$$

$$\text{or} \quad R - O_0 = \sqrt{R^2 - (L/2)^2}$$

$$\text{or} \quad O_0 = \sqrt{R^2 - (L/2)^2} \quad (10.4)$$

Thus, the mid-ordinate  $O_0$  can be calculated from Eq. (10.3) or (10.4).

8. Considering the left half of the long chord, the ordinates  $O_1, O_2, \dots$  are calculated at distances  $X_1, X_2, \dots$  taken from  $D$  towards the tangent point  $T_1$ .

The formula for the calculation of ordinates is deduced as follows.

Let  $P$  be a point at a distance  $x$  from  $D$ . Then  $PP_1$  ( $O_x$ ) is the required ordinate. A line  $P_1P_2$  is drawn parallel to  $T_1T_2$ . From triangle  $OP_1P_2$ ,

$$OP_1^2 = OP_2^2 + P_1P_2^2$$

$$\text{or} \quad R^2 = \{(R - O_0) + O_x\}^2 + x^2 \quad [\text{where, } OP_2 = (R - O_0) + O_x]$$

$$\text{or} \quad R - O_0 + O_x = \sqrt{R^2 - x^2}$$

$$\text{or} \quad O_x = \sqrt{R^2 - x^2} - (R - O_0) \quad (10.5)$$

9. The ordinates for the right half are similar to these obtained for the left half.

## SETTING OUT OF SIMPLE CIRCULAR CURVE BY RANKINE METHOD

### OBJECTIVE:

Setting out of simple circular curve by Rankine method of tangential angle.

### EQUIPMENT:

- Theodolite with Tripod
- Ranging rods
- Arrows
- Tape

### Horizontal Curve Setting by Ranking Method

Let  $AB$  and  $BC$  be two tangents intersecting at  $B$ , the deflection angle being  $\phi$  (Fig. 10.18). The tangent length is calculated and tangent points  $T_1$  and  $T_2$  are marked.

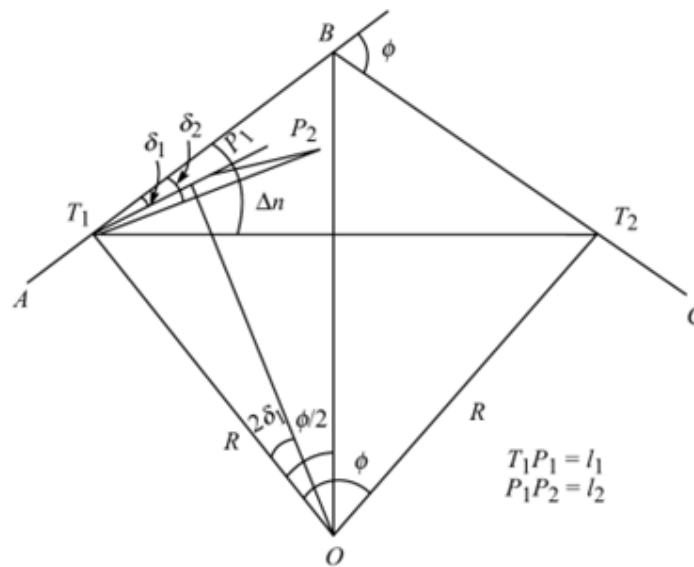

Instrumental Method

Let  $P_1$  = first point on the curve,  
 $T_1P_1 = l_1$  length of first chord (initial sub-chord)  
 $\delta_1$  = deflection angle for first chord  
 $R$  = radius of the curve  
 $\Delta_n$  = total deflection for the chords

Here,  $\angle T_1OP_1 = 2 \times \angle BT_1P_1 = 2\delta_1$

Again,

Chord  $T_1P_1 \sim$  Arc  $T_1P_1$

Now,  $\frac{\angle T_1OP_1}{l_1} = \frac{360^\circ}{2\pi R}$

$$2\delta_1 = \frac{360^\circ \times l_1}{2\pi R}$$

or  $\delta_1 = \frac{360^\circ \times l_1}{2 \times 2\pi R}$  degrees =  $\frac{360 \times 60 \times l_1}{2 \times 2 \times \pi R}$  mins

$$= \frac{1,718.9 \times l_1}{R} \text{ mins}$$

Similarly,  $\delta_2 = \frac{1,718.9 \times l_2}{R}$  mins

$$\delta_3 = \frac{1,718.9 \times l_3}{R} \text{ mins and so on.}$$

Finally,  $\delta_n = \frac{1,718.9 \times l_n}{R}$  mins

Again, when degree of curve  $D$  is given,

$$\delta_1 = \frac{D \times l_1}{60} \text{ degrees}$$

$$\delta_2 = \frac{D \times l_2}{60} \text{ degrees and so on.}$$

Finally,  $\delta_n = \frac{D \times l_n}{60}$  degrees

Arithmetical check:  $\delta_1 + \delta_2 + \delta_3 + \dots + \delta_n = \Delta_n = \phi/2$

**PROCEDURE:**

1. Set the theodolite at the point of curve T1.
  2. With both the plates clamped to zero, direct the theodolite to bisect the point of intersection V. The line of sight is thus in the direction of the rear tangent.
  3. Release the vernier plate and set angle 1 on the vernier .The line of sight is thus directed along chord T1A.
  4. With zero end of tape pointed at T1 and arrow held at a distance  $T1A = c$  along it, swing the tape around T1 till the arrow is bisected by the cross hairs.
  5. Thus the first point A is fixed.
  6. Set the second deflection angle 2 on the vernier so that the line of sight is directed along T1B.
  7. With the zero end of the tape pinned at A, and an arrow held at distance  $AB = C$  along it, swing the tape around A till the arrow is bisected by the cross hairs, thus fixing the point B.
  8. Repeat steps 4 and 5 till last point is reached.
-

# TOTAL STATION

## 1. PREPARATION

### 1.1 Precautions

1. Never point the instrument at the sun without a filter.

2. Never store the instrument in extreme temperatures and avoid sudden changes of temperature.

3. When not using the instrument, place it in the case to avoid shock, dust, and humidity.

4. If there is a great difference in temperature between the work site and the instrument storage location leave the instrument in the case until it adjusts to the temperature of the surrounding environment.

5. Please remove the battery for separate storage if the instrument is to be in storage for an extended time. The battery should be charged once a month during storage.

6. The instrument should be placed in its carrying case during transportation. It is recommended that the original packing case be used for cushioning during extended transportation.

7. Be sure to secure the instrument with one hand when mounting or removing from the tripod.

8. Clean exposed optical parts with degreased cotton or lens tissue only.

9. Clean the instrument's surface with a woolen cloth when finished with use. Dry it immediately if it gets wet.

10. Check the battery, functions, and indications of the instrument as well as its initial setting and correction parameters before operating.

11. Unless you are a maintenance specialist do not attempt to disassemble the instrument for any reason. Unauthorized disassembly of the instrument can result in a void warranty.

12. The total stations emit a laser during operation. DO NOT stare into the beam or laser source when instrument is operation.



## 1.2 Nomenclature



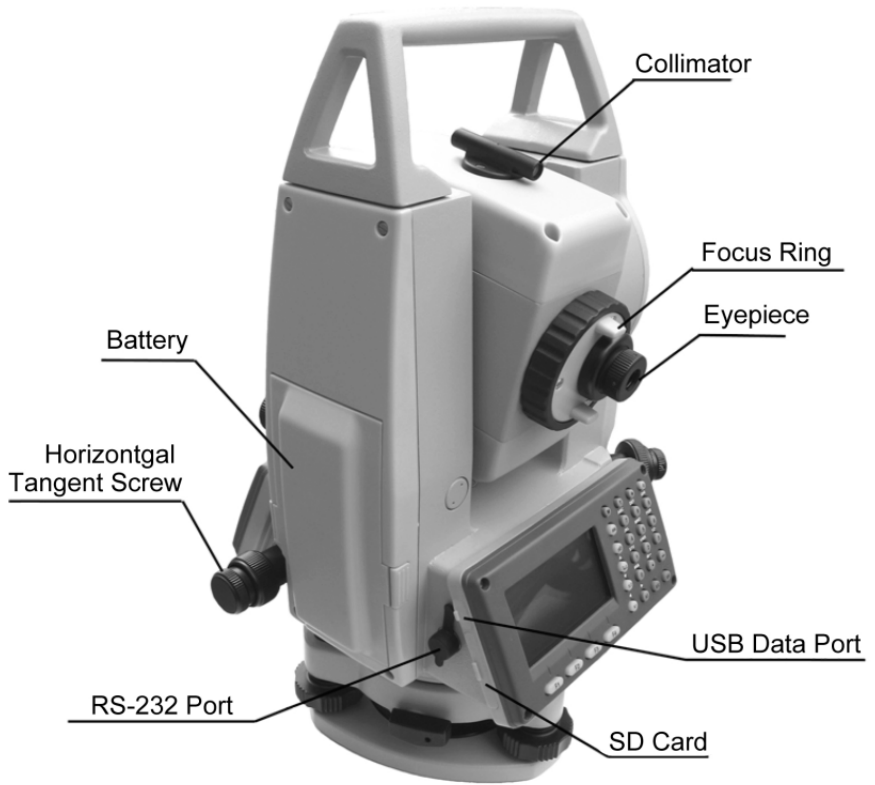

## **1.3 Unpacking and Storage of the Instrument**

### **Unpacking of the Instrument**

Place the case lightly with the cover upward, unlock the case and take out the instrument.

### **Storage of the Instrument**

Replace the cover on the telescope lens, place the instrument into the case with the vertical clamp screw and circular vial upward (objective lens toward the tribrach), tighten the vertical clamp screw, close and lock the case.

## **1.4 Instrument Set Up**

Mount the instrument onto the tripod and secure firmly. Level and center the instrument precisely to ensure the best performance. Use the tripod with a 5/8" tripod screw.

Operation Reference: Leveling and Centering the Instrument

### **1). Setting up the tripod**

First extend the extension legs to suitable length and tighten the screws, firmly plant the tripod in the ground over the point of beginning.

### **2). Attaching the instrument to the tripod**

Secure the instrument carefully on the tripod and slide the instrument by loosening the tripod mounting screw. If the optical plumb

site is positioned over the center of the point tighten the mounting screw.

**3). Roughly leveling the instrument by using the circular vial**

Turn the leveling screw A and B to move the bubble in the circular vial, in which case the bubble is located on a line perpendicular to a line running through the centers of the two leveling screw being adjusted. Turn the leveling screw C to move the bubble to the center of the circular vial. Recheck the position of the instrument over the point and adjust if needed.

**4). Leveling by using the plate vial**

Rotate the instrument horizontally by loosening the Horizontal Clamp Screw and place the plate vial parallel with the line connecting leveling screws A and B, then bring the bubble to the center of the plate vial by turning the leveling screws A and B.

Rotate the instrument  $90^\circ$  (100g) around its vertical axis and turn the remaining leveling screw or leveling C to center the bubble once more.

Repeat the procedures for each  $90^\circ$  (100g) rotation of the instrument and check whether the bubble is correctly centered in all directions.

**5). Centering by using the optical plummet(or laser plummet)**

Adjust the eyepiece of the optical plummet telescope to your eyesight. Slide the instrument by loosening the tripod screw; place the point on the center mark of the optical plummet. Sliding the instrument carefully as to not rotate the axis will allow you to get

the least dislocation of the bubble. (Place star-key after power on, then press F4 (LASER) key, press F1 (ON) key to turn on the laser plummet. Slide the instrument by loosening the tripod screw; Place laser facular on the occupied pointing, Sliding the instrument carefully as to not rotate the axis will allow you to get the least dislocation of the bubble. The last, press ESC key, and laser plummet turn off automatically.)

#### **6). Complete leveling the instrument**

Level the instrument precisely as in Step 4. Rotate the instrument and check to see that the bubble is in the center of the plate level regardless of the telescope direction then tighten the tripod screw firmly.

## **1.5 Battery Removal & Insertion – Information and Recharging**

### **Battery removal & insertion**

Insert the battery into the battery slot and push the battery until it clicks.

Press the right and left buttons of the battery compartment to remove the battery.

### **Battery information**

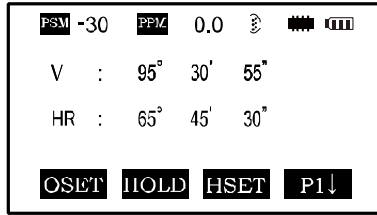

 ----- Indicates that battery is fully charged

 ----- Indicates that the battery can only be used for about 1 hour.

Recharge the battery or prepare a recharged battery for use.

 ----- Recharge the battery or prepare a recharged battery for use.

Note: The working time of the battery is determined by environment conditions, recharging time, and other factors.

### Battery Recharging

Battery should be recharged only with the charger supplied with the instrument.

Remove the on-board battery from instrument as instructed and connect to the battery charger.

### Battery Removal Caution

▲ Before you take the battery out of the instrument, make sure that the power is turned off. Otherwise the instrument can be damaged.

### Recharging Caution:

▲ The charger has built-in circuitry for protection from

overcharging. However, do not leave the charger plugged into the power outlet after recharging is completed.

▲Be sure to recharge the battery at a temperature of 0°C~45°C, recharging may be abnormal beyond the specified temperature range.

▲When the indicator lamp does not light after connecting the battery and charger the battery or the charger may be damaged.

**Storage Caution:**

▲The rechargeable battery can be repeatedly recharged 300-500 times. Complete discharge of the battery may shorten its service life.

▲In order to get the maximum service life be sure to recharge the battery at least once a month.

## **1.6 Reflector Prisms**

When doing distance measuring in prism mode a reflector prism needs to be placed as the target. Reflector systems can be single or multiple prisms which can be mounted with a tripod/tribrach system or mounted on a prism pole. Unique mini prism systems allow setups at

corners that are hard to reach. Reflectorless targets extend the range of the instrument when used in reflectorless mode.

Illustrated are some prisms and a reflector compatible with instruments:



## 1.7 Mounting and Dismounting the Instrument from the Tribrach



## Dismounting

When necessary the instrument can be dismounted from the tribrach. Loosen the tribrach locking screw in the locking knob with a screwdriver if necessary. Turn the locking knob 180 degrees counter-clockwise to disengage anchor jaws and remove the instrument from the tribrach.

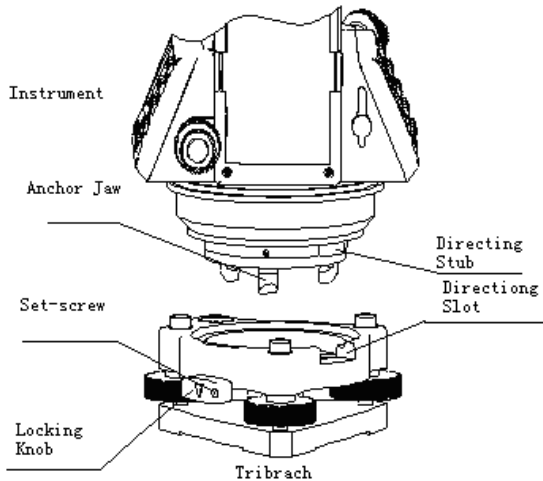

## Mounting

Insert three anchor jaws into holes in tribrach and line up the directing stub on the instrument with the directing slot of the tribrach. Turn the locking knob 180 degrees clockwise and tighten the locking screw with a screwdriver.

## 1.8 Eyepiece Adjustment and Object Sighting

## Method of Object Sighting (for reference)

Sight the telescope to the sky and rotate the eyepiece tube to make the reticule clear.

Collimate the target point with top of the triangle mark in the collimator. (keep a certain distance between eye and the collimator).

Make the target image clear with the telescope focusing screw.

If there is parallax when your eye moves up and down or left and right this indicates the diopter of the eyepiece lens or focus is not adjusted well and accuracy will be effected. You should readjust the eyepiece tube carefully to eliminate the parallax.

## 1.9 Turning the instrument On and Off

### Power on

1. Be sure that the instrument is leveled.
2. Press and momentarily hold the power (POWER) key.
3. Rotate the EDM head in an upwards direction to initialize.
4. To turn OFF press and hold the power key until instrument powers down.

Be sure there is sufficient battery power. If 'Battery Empty' is shown on the display, the battery should be recharged or replaced.

**\*\*\* DO NOT remove the battery during measuring, otherwise the data will be lost and the instrument could be harmed!! \*\*\***

## 1.10 How To Enter Alphanumeric Characters

\*How to select an item

[Example 1] Select INS.HT (instrument height) in the data collection mode (first press the MENU button then F1:DATA COLLECT and then select the data file desired. Press F2 to list, the arrow keys to choose and then F4 to select). Press F1 again for OCC.PT# INPUT.

The arrow (→) indicates an item to enter. Press [▲] [▼] key to move the arrow line up or down

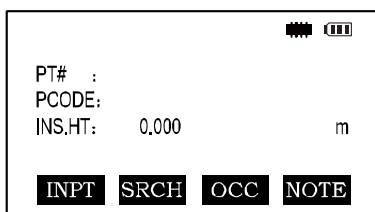

```
PT# :
PCODE:
INS.HT: 0.000 m

INPT SRCH OCC NOTE
```

Press [▼] move→R..HT

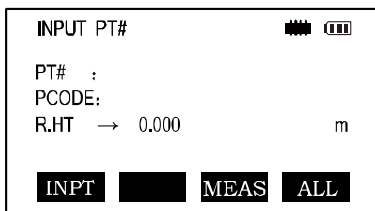

```
INPUT PT#
PT# :
PCODE:
R.HT → 0.000 m

INPT [ ] MEAS ALL
```

Press **F1** INPUT then **1** to input "1"

Press **.** to input "."

Press **5** to input "5", press **ENT**

Then R. HT =1.5 m

### \*How to enter characters

[Example 2] Input the code “ABC1” of instrument point in Data Collection Mode.

1. Move the arrow to PCODE using the [▲] or [▼] key

INPUT OCC. [Signal] [Battery]

PT# :

PCODE →

R.HT : 0.000 m

[INPT] [SRCH] [MEAS] [ALL]

2. Press [F1] (input) key

INPUT OCC. [Signal] [Battery]

PT# :

PCODE →

R.HT : 0.000 m

[BACK] [RETN] [NUMB] [ ]

3. Press [F1] key once

INPUT OCC. [Signal] [Battery]

PT# :

PCODE ABC1

R.HT : 0.000 m

[BACK] [RETN] [NUMB] [ ]

Press [7] key once for “A”

Press [7] key twice for “B”

Press [7] key three times for “C”

Press [1] key once for “1” (\*Press F3 to switch to NUMB mode first)

Press enter key to finish input

## 2. FUNCTION KEY AND DISPLAY

## 2.1 Operating Key



Keys	Names	Function
	Angle meas. key	Angle measurement mode
	Distance meas. key	Distance measurement mode
	Coordinate meas. key	Coordinate measurement mode (▲Up)
	Layout key	Layout measurement mode (▼ Down)
	Quick key 1	User-defined quick key 1 (◀ Left)
	Quick key 2	User-defined quick key 2 (▶ Right)
	Escape key	Return to the measurement mode or previous layer mode.
	Enter key	Press after confirmation of inputting values
	Menu key	Switches menu mode and normal mode
	Shift key	Shift distance measuring key
	Star key	Press once to adjust contrast or twice for illumination of keypad
	Power key	On / Off key press and hold
	Soft key (Function)	Responds to the message displayed

	key)	
0- 9	Number key	Input numbers
—	Minus key	Input minus sign, displays electronic bubble
.	Point key	On / Off laser pointing function

Display marks:

Display	Content
V	Vertical angle
V%	Vertical angle as a percentage (Gradient display)
HR	Horizontal angle (right)
HL	Horizontal angle (left)
HD	Horizontal distance
VD	Elevation difference
SD	Slope distance
N	North coordinate
E	East coordinate
Z	Z or elevation coordinate
*	EDM working
m/ft	Switches units between meters and feet
m	Meter unit
S/A	Sets temperature, air pressure, prism constant
PSM	Prism constant (unit:mm)
PPM	Atmospheric correction

## 2.2 Function Key

Angle measurement mode (three-page menu)

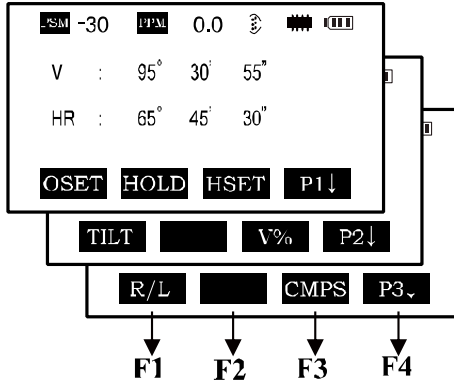

Page	Keys	Display marks	Function
P1	<b>F1</b>	OSET	Horizontal angle is set to 0° 0' 0"
	<b>F2</b>	HOLD	Hold the horizontal angle
	<b>F3</b>	HSET	Set a required horizontal angle by entering numbers
	<b>F4</b>	P1 ↓	Scroll to the next page (P2)
P2	<b>F1</b>	TILT	Tilt correction screen. If the correction is turned on the display will show the tilt correction value.
	<b>F2</b>		
	<b>F3</b>	V%	Vertical angle percent grade (%) mode
	<b>F4</b>	P2 ↓	Scroll to the next page (P3)
P3	<b>F1</b>	R/L	Switches Right/Left rotation of horizontal angle
	<b>F2</b>		
	<b>F3</b>	CMPS	Switches vertical angle "0" position
	<b>F4</b>	P3 ↓	Scroll to the next page (P1)

**Distance measurement mode (two-page menu)**

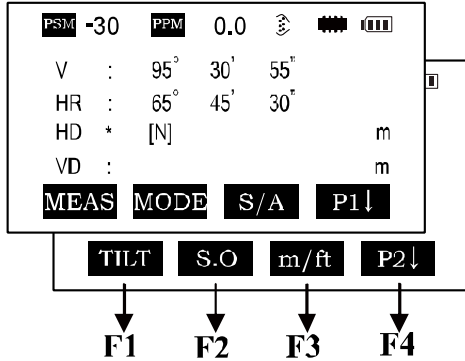

Page	Keys	Display marks	Function
P1	<b>F1</b>	MEAS	Begin measuring
	<b>F2</b>	MODE	Sets measuring mode, Fine/--/Tracking
	<b>F3</b>	S/A	Sets temperature, air pressure, prism constant
	<b>F4</b>	P1 ↓	Scroll to the next page (P2)
P2	<b>F1</b>	OFSET	Selects Off-set measurement mode
	<b>F2</b>	S. O.	Selects Stake Out measurement mode
	<b>F3</b>	m / ft	Switches units between meters and feet
	<b>F4</b>	P2 ↓	Scroll to the next page (P1)



**Coordinate measurement mode (three-page menu)**

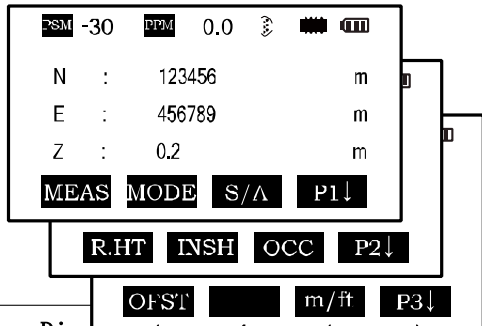

Page	Keys	Display marks		Function
		F1	F2	
P1	F1	MEAS		Start measuring
	F2	MODE		Sets a measuring mode, Fine/Tracking
	F3	S/A		Sets temperature, air pressure, prism constant
	F4	P1 ↓		The function of soft keys is shown on next page (P2)
P2	F1	R. HT		Sets prism height
	F2	INSHT		Sets instrument height
	F3	OCC		Sets instrument coordinate.
	F4	P2 ↓		Shows the function of soft keys on page 3

P3	F1	OFSET	Off-set measurement mode
	F2	BACKSIGHT	Setting a direction angle for backsight orientation
	F3	m / ft	Switches meter and feet unit.
	F4	P3↓	Shows the function of soft keys on page1

## 2.3 star-key mode

### The total station(non-reflectorless):

Press the star key , following is displayed:

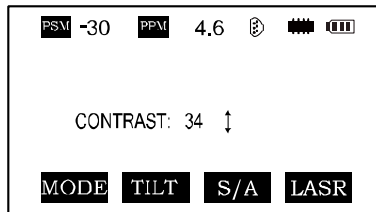

1. Contrast adjustment: After pressing star key, adjust the display contrast by pressing [▲] or [▼] key.

2. Illumination: After pressing star key, select [Illumination] by pressing F1(LAMP) key or press star key.

3. Tilt: After pressing star key, select [tilt] by pressing F2 (TILT) key, and select ON or OFF by pressing F1 or F3 key, press F4 (ENT) key.

4. S/A: After pressing star key, select [S/A] by pressing F3 (S/A) key, then you can set Prism contrast, air pressure and temperature.

5. Laser plummet: If total station has this function, after pressing star key, select [laser] by pressing F4 (LASR) key, and select ON or OFF by pressing F1 or F2 key.

\*In some interface, you can turn on or turn off panel backlight by press star key directly.

### The total station(reflectorless):

Press the star key , following is displayed:

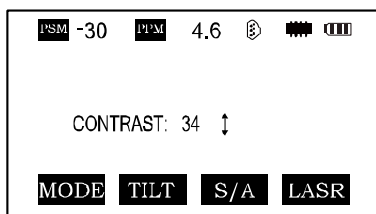

1. Mode: Press the **F1** (mode) key, the following is displayed :

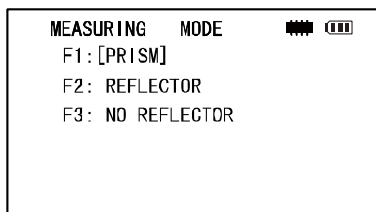

You can select the type of measure mode by pressing the **F1**—**F3** keys.

2. You can turn on the lamp by pressing the star key once more or

by pressing twice from any menu.

## 2.4 Dot-key Mode

The total station can function as a laser pointer

The laser pointer can be turned on or off by pressing the (.) dot key.

## 3. INITIAL SETTINGS

The series total station can be reset to the instruments original factory settings.

See Section 11 “Basic Settings”

### 3.1 Setting the Temperature and Atmospheric Pressure

Measure the surrounding temperature and air pressure in advance.

Example: temperature +25° , air pressure 1017.5 hPa

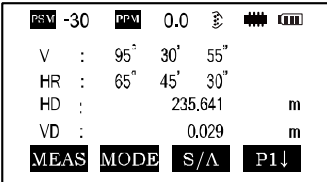
Procedure	Operation	Operating procedure	Display
		Enter the Distance Measurement Mode	 <pre> PRM -30  PRM 0.0  [Signal] [Battery] V : 95° 30' 55" HR : 65° 45' 30" HD : 235.641 m VD : 0.029 m MEAS  MODE  S/Δ  P1↓                     </pre>

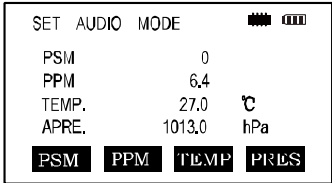
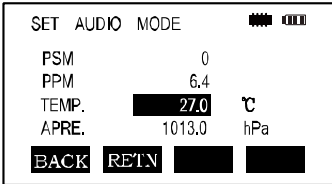
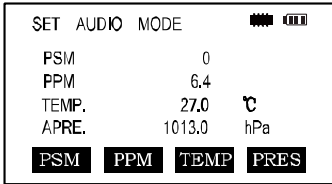
	<b>F3</b>	Press <b>F3</b> to enter the S/A screen	
Temp. Settings	<b>F3</b>	Press <b>F3</b> to enter temperature section, enter the correct temperature, press the ENT key to set	
Atms. Pressure	<b>F2</b>	Press <b>F2</b> key and enter the air pressure, press the ENT key to confirm	
Remarks	<p>Temperature operating range: -30° ~+60°C or -22~+140°F</p> <p>Air pressure: 560~1066 hPa or 420~800 mmHg or 16.5~31.5 inHg</p> <p>If the atmospheric correction value calculated from the temperature and air pressure exceeds the range of ± 999.9PPM, the operation will return to step 4 automatically, and you should enter the data again.</p>		

### 3.2 Setting of the Atmospheric Correction

The infrared emitted by the Total Station varies with the air temperature and pressure. Once the atmospheric correction value is

set the instrument will correct the distance measuring result automatically.

Air pressure: 1013hPa

Temperature: 20°C

The calculation of atmospheric correction :

$$\Delta S = 273.8 - 0.2900 P / ( 1 + 0.00366T ) \text{ (ppm)}$$

$\Delta S$ : Correction Coefficient (Unit ppm)

P: Air Pressure (Unit : hPa If the unit is mmHg, please convert using

$$1\text{hPa} = 0.75\text{mmHg}$$

T: temperature ( unit°C)

### Direct Setting Method of Atmosphere Correction Value

After measuring the temperature and air pressure the atmosphere correction value can be obtained from an atmospheric correction chart or correction formula (PPM).

Procedure	Operation	Operation Procedure	Display
	F3	Press <b>F3</b> Key in distance measurement or coordinate measurement mode	<pre> SET AUDIO MODE  [Speaker] [Battery] PSM              0 PPM              6.4 TEMP.           27.0 °C APRE.           1013.0 hPa PSM  PPM  TEMP  PRES                     </pre>

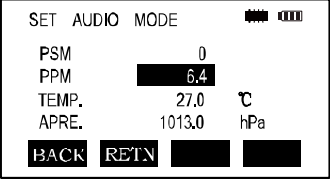
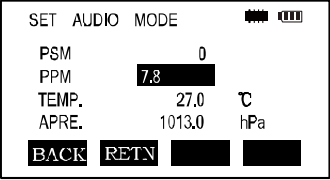
	F2	Press <b>F2</b> [ppm] key, which shows the current setting value	
	Enter value	Enter atmospheric correction and press ENT	
<p>*1) See 2.10 “How to Enter Alphanumeric Characters”  Input range: -999.9PPM to +999.9 Step length: 0.1PPM  *2) If Temperature and Atmospheric Pressure are reset, the PPM will be recalculated automatically.</p>			

### 3.3 Setting of the Prism Constant

In the factory the prism constant for the total station is set at -30mm. If the constant of the prism used is not -30mm, you must change this setting. Once the prism constant is set it will become the new default value until changed.

Procedure	Operation	Operation Procedure	Display
-----------	-----------	---------------------	---------

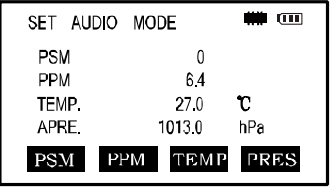
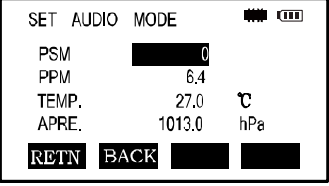
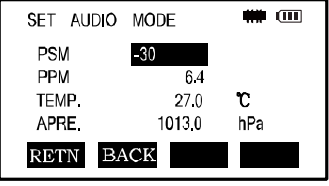
	<b>F3</b>	Press <b>F3</b> (S/A) Key in Distance Measurement Mode or Coord. Measurement Mode.	
②	<b>F1</b>	② Press <b>F1</b> PRISM key	
③	Enter data	Press <b>F1</b> (INPUT) key to enter the Prism Constant correction value. *1, press <b>F4</b> to confirm and return to the Setting Mode.	
Input range: -99. 9mm to +99. 9mm Step length 0. 1mm			

\*The total station in reflectorless measuring mode sets the prism constant to 0 automatically.



## **4. ANGLE MEASUREMENT**

### **4.1 Measuring Horizontal Angle Right and Vertical**

# Angles

Make sure the angle measurement mode is selected.

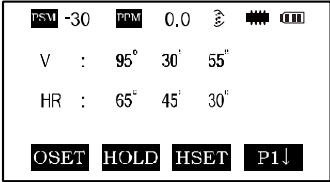
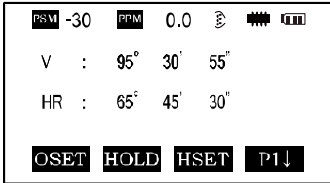
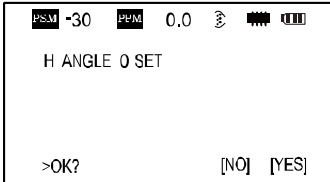
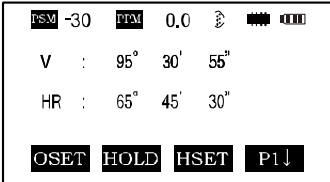
Operation procedure	Operation	Display
① Collimate the first target (A)	Collimate A	
To set horizontal angle of target A at 0° 00' 00" press the <b>F1</b> (OSET) key and then press the <b>F4</b> (YES) key	<b>F1</b>  <b>F4</b>	 
③ Collimate the second target (B) The required V/H angle to target B will be displayed	Collimate B	

Note : The horizon angle will be saved when the instrument is powered off and displayed when powered on.

## Reference: How to Collimate

Point the telescope toward a light surface or sky. Turn the diopter ring and adjust the diopter so that the cross hairs are clearly observed.

Aim the target at the peak of the triangle mark of the sighting collimator. Allow a certain space between the sighting collimator and yourself for collimating.

Focus the target with the focusing knob.

If parallax is created between the cross hairs and the target when viewing vertically or horizontally while looking into the telescope, focusing is incorrect or diopter adjustment is poor.

This adversely affects precision in measurement please eliminate the parallax by carefully focusing and using the diopter adjustment.

## 4.2 Switching Horizontal Angle Right/Left

Make sure the angle measurement mode is selected.

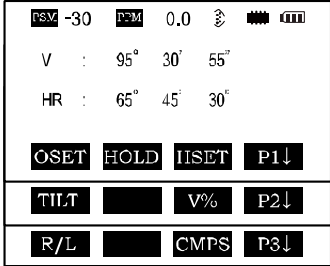
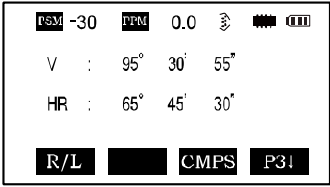
Operation procedure	Operation	Display
Press the <b>F4</b> Key twice to get the menu to page 3. (P3)	<b>F4</b> twice	
Press the <b>F1</b> (R/L) key. The Horizontal Right angle mode (HR) Switches to Horizontal Left mode (HL)	<b>F1</b>	
Measure as HL mode		
*Each time the <b>F2</b> (R/L) key is pressed the HR/HL mode switches		

## 4.3 Setting of the Horizontal Angle

### 4.3.1 Setting by Holding the Angle

Make sure the angle measurement mode is selected.

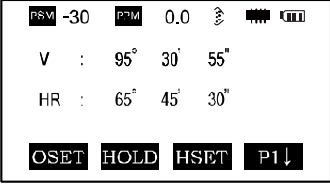
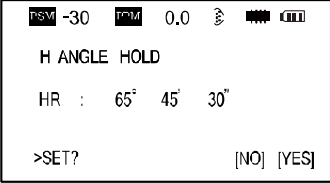
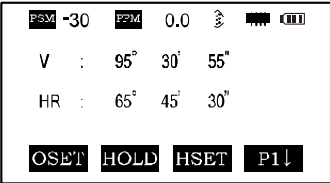
Operation procedure	Operation	Display
① Set the required horizontal angle using the horizontal tangent screw	Display angle	
② Press the <b>F2</b> (HOLD) key	<b>F2</b>	
③ Collimate the target	Collimate	
④ Press the <b>F4</b> (YES) key to finish holding the horizontal angle, the display turns back to the normal angle measurement mode	<b>F4</b>	

\*To return to the previous mode, press the ESC key.

### 4.3.2 Setting the Horizontal Angle from the Keypad

Make sure the angle measurement mode is selected.

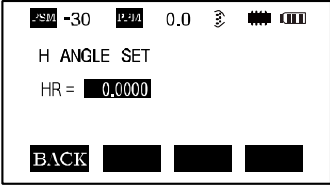
Operation procedure	Operation	Display
①Collimate the target	Collimate	
②Press the <b>F3</b> (HSET) key	<b>F3</b>	

③ Input the required horizontal angle by using the keys, for example: 150.10.20, inputs 150°10'20". Press **ENT**. Carry on normal measurement after entering the required horizontal angle

150.10.2  
0  
**ENT**

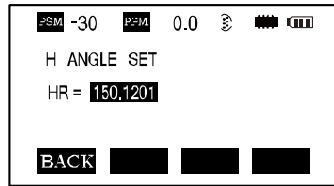

## **5. DISTANCE MEASUREMENT**

When setting the atmospheric correction obtain the correction value by measuring the temperature and pressure.

### **5.1 Setting of the Atmospheric Correction**

When setting the atmospheric correction obtain the correction value by measuring the temperature and pressure. Refer to Section 3.2 “Setting of the Atmospheric Correction” .





### **5.2 Setting of the Correction for Prism Constant**

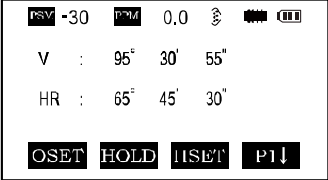

The instrument is preset for a Prism Constant value of -30mm at the factory. If the prism is of another constant the instrument needs to be updated with this constant. Refer to Chapter 3.3 “Setting of the Prism Constant” . The updated value is kept in the instrument memory after the power is shut off.

### 5.3 Distance Measurement (Continuous Measurement)

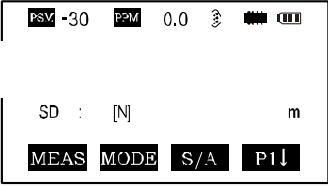
Make sure the angle measurement mode is selected.

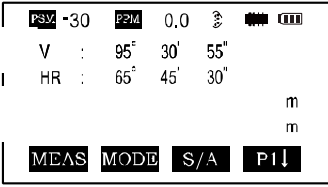



Operation procedure	Operation	Display
Collimate the center of prism *1	Collimate	
 distance measurement starts *2 *3;		
③ The measured distances are shown (*4, *7) By  key again the instrument returns to horizontal view, vertical (V) angle, vertical distance (VD) and slope distance (SD)		

- \*1) The total station prism mode collimate center of prism when measuring;
- \*2) When EDM is working, the “\*” mark appears in the display. The total stations will display “weak signal” when measuring if the signal is weak.
- \*3) To change the mode from Fine to Tracking, refer to section 5.4 “Fine mode / Tracking Mode” . To set the distance measurement on when the instrument is powered up, refer to Chapter 11 “Basic Settings” .
- \*4) The distance unit indicator “m” (for meter) or “ft” (for feet) appears and disappears alternatively with a buzzer sounding at every renewal of distance data.
- \*5) Measurement may repeat automatically in the instrument if the result is affected by external factors\*.
- \*6 ) To return to the angle measuring angle mode from the distance-measuring mode, press the ANG key.
- \*7) It is possible to choose the display order (HR, HD, VD) or (V, HR, SD) for initial measuring mode. Refer to Chapter 11 “Basic Settings”.

## 5.4 Changing the Distance Measurement Mode (Repeat Measurement / Single Measurement/ Track Measurement)

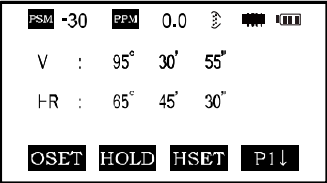
Make sure the angle measurement mode is selected.

Operation procedure	Operatio n	Display

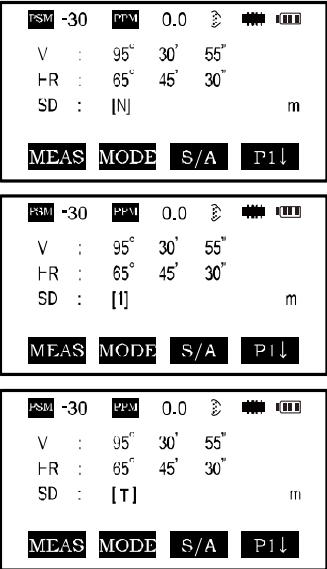
Collimate the center of the prism	Collimate	
 key , Continue Measurement begins *1;		
Press the <b>F2</b> (MODE) key to switch between Repeat Measurement, Single Measurement and Tracking Measurement. [N], [1], [T]	<b>F2</b>  <b>F1</b>	
<p>*1 It is possible to set the measurement mode for N-times measuring mode or continuous measurement mode when the power is turned on. Refer to Chapter 11 “Basic Settings” .</p>		

## 5.5 Stake Out (S.O.)

The difference between the measured distance and the input stake out distance is displayed.

**Measured distance - Stake out distance = Displayed value**

In a stake out operation you can select either horizontal distance (HD), relative elevation (VD), and slope distance (SD.)

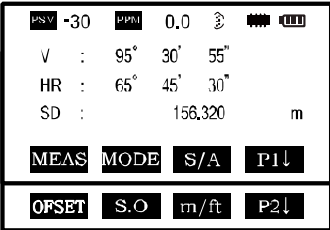
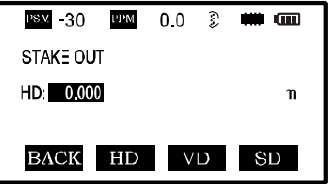
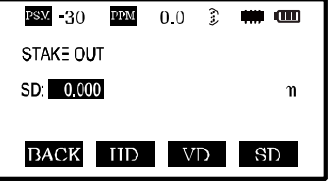
Operation procedure	Operation	Display
Press the <b>F4</b> (↓) key in the distance measuring mode to menu P2	<b>F4</b>	
Press the <b>F2</b> (S.O) key The data previously set is shown	<b>F2</b>	
Select the measuring mode by pressing the <b>F2</b> to <b>F4</b> keys. F2:HD, F3:VD, F4:SD	<b>F1</b>	

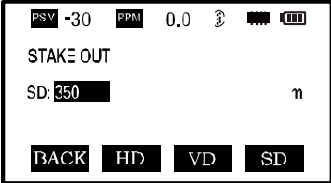
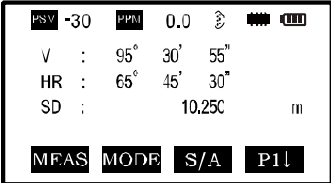
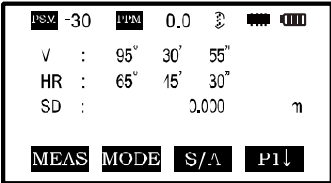
<p>Enter the distance 350 , press <b>F4</b></p>	<p>Enter 350 <b>F4</b></p>	
<p>Collimate the target (Prism), measurement starts. The difference between the measured distance and the stake out distance is displayed.</p>	<p>Collimate Prism</p>	
<p>Move the target until the difference becomes 0.</p>		
<p>To return to normal distance measurement mode, stake out distance to “0” or switch to other measurement mode.</p>		

## 5.6 Offset Measurement

There are four offset measurement modes:

<p>To show the coordinate of po: key. *1*2</p>		<div style="border: 1px solid black; padding: 5px;"> <p style="text-align: right;">COLLIMATE OBJECT <span style="float: right;">🌀 🔋 🔌</span></p> <p>N : 365.332 m</p> <p>  : 15.300 m</p> <p>Z : 1.230 m</p> <p style="text-align: right;"> <span style="background-color: black; color: black;">  </span> <span style="background-color: black; color: black;">  </span> <span style="background-color: black; color: black;">  </span> <span style="background-color: black; color: black;">NEXT</span> </p> </div>
--	---	---

- \*1) To return to procedure 5, press **F4** (NEXT) key
- \*2) To escape the measuring, press **ESC** key, the display returns to the previous mode.

## 6. COORDINATE MEASUREMENT

### 6.1 Execution of Coordinate Measurement

Measure the coordinates by entering the instrument height and prism height, coordinates of unknown Point will be measured directly.

\* When setting coordinate values of occupied point, see Section

#### 6.2 “Setting Coordinate Values of Occupied Station Point” .

\* When setting the instrument height and prism height, see Section

#### 6.3 “Setting Height of the Instrument” and 6.4 “Setting Height of Target (prism Height)” .

\* To set backsight, determine the backsight azimuth or check the known azimuth, coordinate and distance.

The coordinates of the unknown point are calculated as shown below and displayed:

Coordinates of occupied point: (NO, EO, ZO)

Instrument height :INS. HT

Prism height: R. HT

---

Vertical distance (Relative elevation):  $Z$  (VD)

Coordinates of the center of the prism, originated from the center point of the instrument:  $(n, e, z)$

Coordinates of unknown point:  $(N1, E1, Z1)$

$$N1=N0+n$$

$$E1=E0+e$$

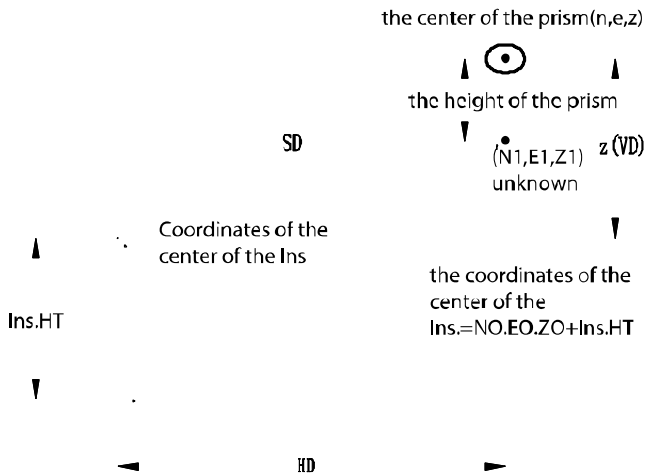

$$Z1=Z0+INS.HT+Z-R.HT$$

Center point of the instrument  $(N0, E0, Z0+INS.HT)$



When doing coordinate measurement coordinates of occupied point, the instrument height, the prism height and back sight azimuth should be set.

Operation procedure	Operation	Display
Set the direction angle of known	Set	<div style="border: 1px solid black; padding: 5px;"> <div style="display: flex; justify-content: space-between; font-size: small;"> <span>PSM -30</span> <span>PPM 0.0</span> <span>☺</span> <span>■■■■</span> <span>000</span> </div> <div style="margin-top: 5px;"> <p>V : 95° 30' 55"</p> <p>HR : 65° 45' 30"</p> </div> <div style="display: flex; justify-content: space-around; font-size: small; margin-top: 5px;"> <span>OSET</span> <span>HOLD</span> <span>HSET</span> <span>P1↓</span> </div> </div>

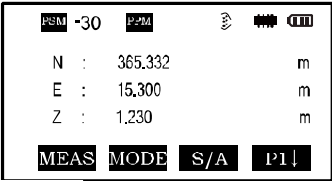
point A *1 )	directio n angle	
Collimate target prism B,  key	Collima te target prism 	
<p>*1Refer to Section 4.3 “Setting of Horizontal Angle” . In case the coordinate of instrument point is not entered, (0,0,0) will be used as the default for the instrument point. The prism height will be calculated as 0 when the prism height is not set.</p>		

## 6.2 Setting Coordinate Values of Occupied Point

Set the coordinates of the instrument (occupied point) according to known values and the instrument automatically converts and displays the unknown point (prism point) coordinates following the observation.

The instrument retains the coordinates of the occupied point after turning the power off.



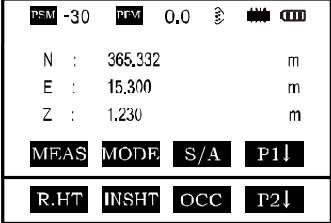
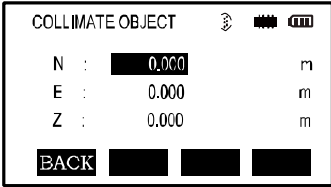

Operation procedure	Operation	Display
Press the <b>F4</b> (P1↓) key from the coordinate measurement mode to get the function on menu P2.	<b>F4</b>	
Press the <b>F3</b> (OCC) key	<b>F3</b>	

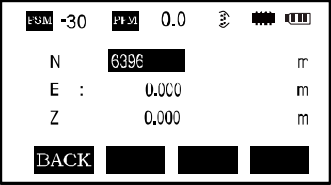
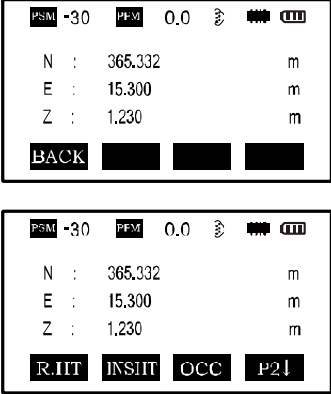
<p>③Enter N coordinate value</p>	<p>Enter data</p> <p><b>ENT</b></p>	
<p>④Enter E and Z coordinate values in the same manner. After entering the values, the display returns to the coordinate measuring display menu.</p>	<p>Enter data</p> <p><b>ENT</b></p>	
<p>Input range: -999999.999m/ft ≤ N、E、Z ≤ +999999.999m/ft</p>		

### 6.3 Setting Height of the Instrument

The instrument height value will be retained after the instrument is powered off.

Operation procedure	Operation	Display
	n	

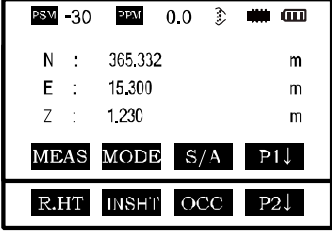
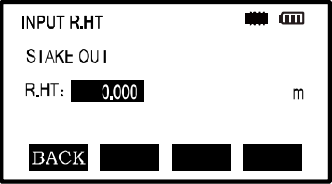
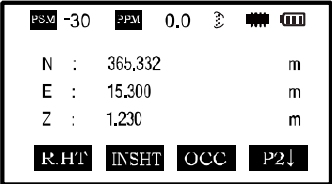
<p>Press the <b>F4</b> (P1↓) key from the coordinate measurement mode to access the P2 menu screen.</p>	<p><b>F4</b></p>	
<p>② Press the <b>F2</b> (I.HT) key, The current value is displayed.</p>	<p><b>F2</b></p>	
<p>Enter the instrument height and press the <b>ENT</b> key to get to the coordinate measuring display</p>	<p>Enter the I. H. <b>ENT</b></p>	
<p>Input range: <math>-999.999 \leq \text{INS. HT} \leq +999.999\text{m}</math></p>		

## 6.4 Setting Height of Target (Prism Height)

This mode can be used to obtain z coordinate values. The target height value will be retained after the instrument is powered off.

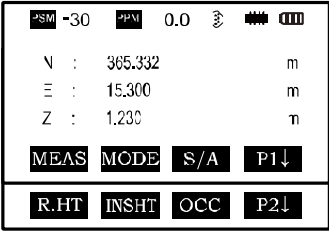
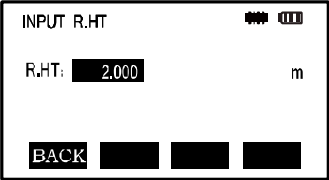
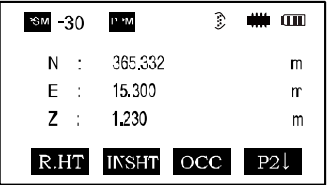
Operation procedure	Operation	Display
Press the <b>F4</b> (P1↓) key from the coordinate measurement mode to access the P2 menu screen.	<b>F4</b>	
② Press the <b>F1</b> (R.HT) key. The current value is displayed.	<b>F1</b>	
Enter the prism height, then press the <b>ENT</b> key to get to the coordinate measuring display	Enter the prism height <b>ENT</b>	
Input range: $-999.999\text{m} \leq \text{prism height} \leq +999.999\text{m/ft}$		

## 7. SURVEYING PROGRAM

### Surveying Program Mode (programs)

By pressing the menu key **M** , the instrument will be in Menu Mode.

## 7.1 Remote Elevation Measurement (REM)

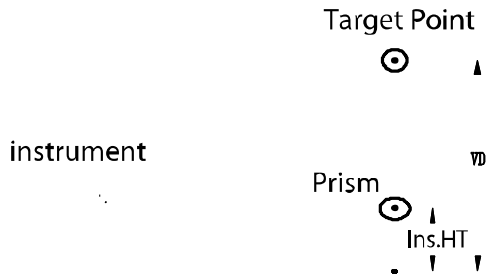

To obtain elevation of the point at which setting the target prism is not possible, place the prism at any point on the vertical line from the target then carry out REM procedure as follows.



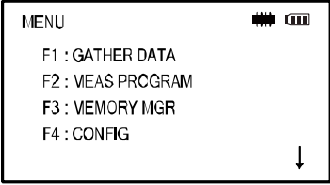
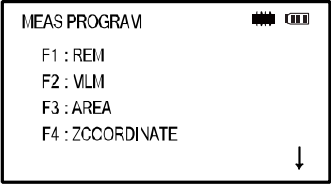
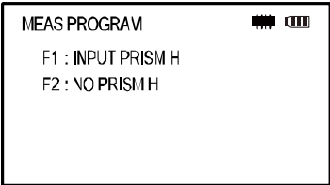
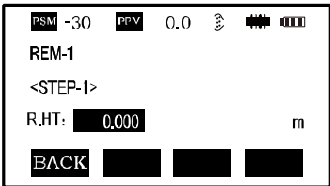
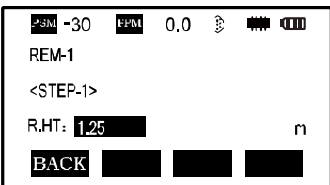

### 1) With prism height (h) input

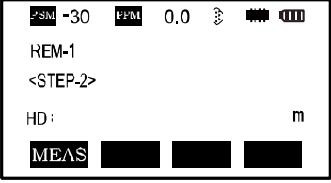
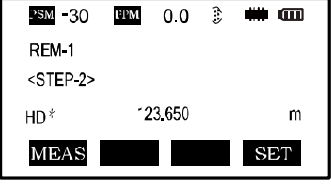
Operation procedure	Operatio n	Display

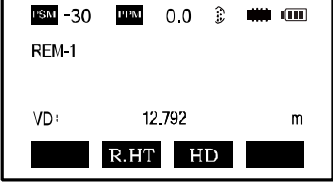
<p>Press the <b>M</b> Key</p>	<p><b>M</b></p>	
<p>Press the <b>F2</b> key, enter MEAS PROGRAM. menu</p>	<p><b>F2</b></p>	
<p>③ Press the <b>F1</b> (REM) key</p>	<p><b>F1</b></p>	
<p>④ Press the <b>F1</b> key</p>	<p><b>F1</b></p>	
<p>⑤ Enter prism height (1.3 is an example in meters)</p>	<p><b>F1</b> Enter prism height 1.3 <b>F4</b></p>	

<p>⑥ Collimate prism</p>	<p>Collimate Prism</p>	
<p>⑦ Press the <b>F1</b> (MEAS) key, measurement starts. Horizontal distance (HD) between the instrument and prism will be shown.</p>	<p><b>F1</b></p>	
<p>⑧ Press the <b>F4</b> (SET) The prism position will be decided.</p>	<p><b>F4</b></p>	
<p>⑨ Collimate target K. Vertical distance (VD) will be shown.</p>	<p>Collimate K</p>	
<p>To return to procedure 5, press <b>F2</b> (R. HT) key.  To return to procedure 6, press <b>F3</b> (HD) key.  To return to PROGRAMS Menu, press the <b>ESC</b> key.</p>		

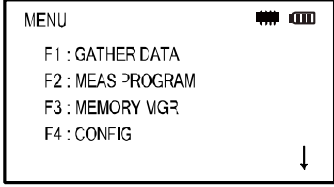
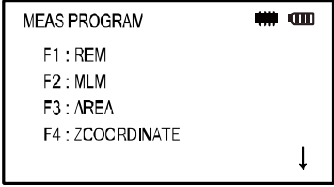
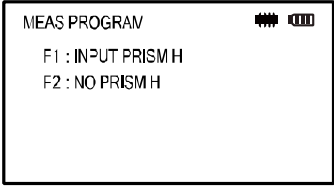
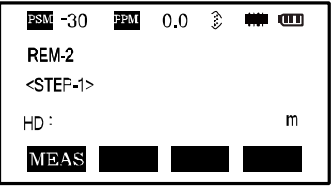
## 2) Without prism height input

Operation procedure	Operation	Display
Press the <b>M</b> menu key	<b>M</b>	
Press the <b>F2</b> key, enter the measure programs menu.	<b>F2</b>	
③ Press the <b>F1</b> (REM) Key.	<b>F1</b>	
④ Press the <b>F2</b> key to select the mode without prism height.	<b>F2</b>	
Collimate prism, press the <b>F1</b> (MEAS) key. Measuring starts. Horizontal distance (HD) between the instrument and target will	Collimate target	

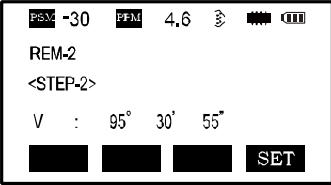
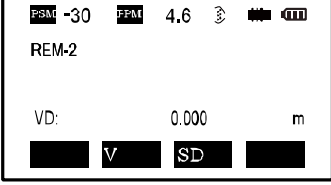
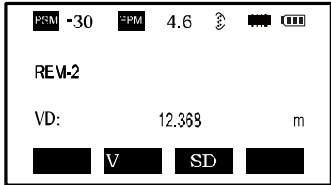

be shown. .		
<p>©Press the <b>F4</b> (SET)</p> <p>The target position will be decided.</p>	<b>F4</b>	
<p>Collimate ground point G , press the <b>F4</b> (SET) key. The position of point G will be decided</p>	<b>F4</b>	
<p>Collimate target K</p> <p>Vertical distance (VD) will be shown</p>	Collimat e K	
<p>To return to procedure 5, press the <b>F3</b> (HD) key.</p> <p>To return to procedure 6, press the <b>F2</b> (V) key.</p> <p>To return to PROGRAMS Menu, press the <b>ESC</b> key.</p>		

## 7.2 Missing Line Measurement (MLM)

Measurement for horizontal distance (dHD) , slope distance (dVD), elevation (dVR) and horizontal bearing (HR) between two target prisms.

It is possible to enter the coordinate value directly or calculate

from coordinate data file.

MLM Mode has two modes:

1. MLM-1 (A-B, A-C): Measurement A-B, A-C, A-D
2. MLM-2 (A-B, B-C): Measurement A-B, B-C, C-D

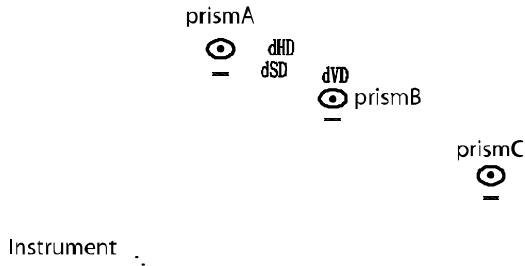

It is necessary to set the direction angle of the instrument.

[Example] MLM-1 (A-B, A-C)

Procedure of MLM-2 (A-B, B-C) mode is completely the same as that of MLM-1 mode.

Operation procedure	Operatio n	Display

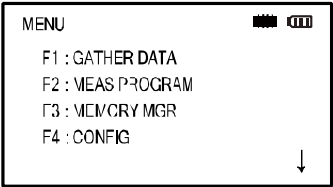
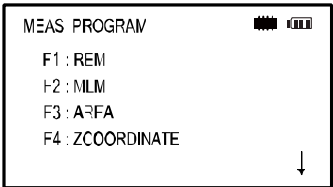
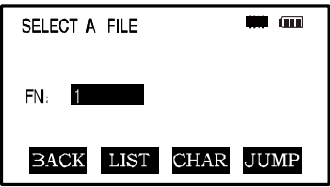
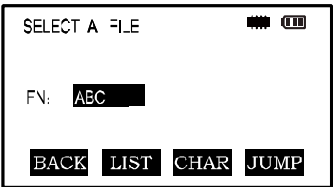
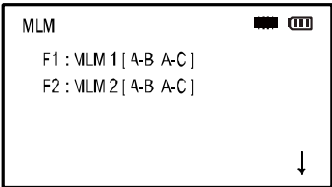
<p>① Press the <b>M</b> menu key</p>	<p><b>M</b></p>	
<p>② Press the <b>F2</b> key, enter MEAS PROGRAMS</p>	<p><b>F2</b></p>	
<p>③ Press the <b>F2</b> (MLM) key</p>	<p><b>F2</b></p>	
<p>④ Enter file name</p>	<p>Enter file name</p>	
<p>⑤ Press <b>ENT</b> key.</p>	<p><b>ENT</b></p>	

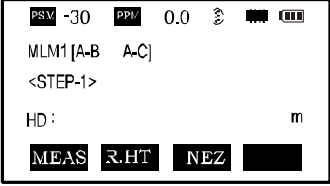
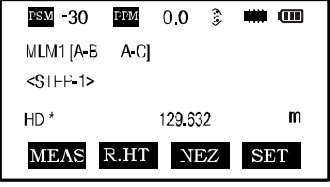
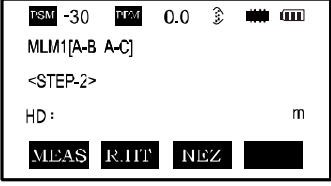
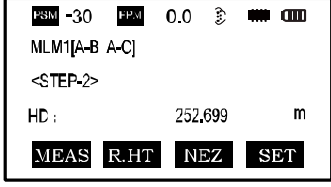
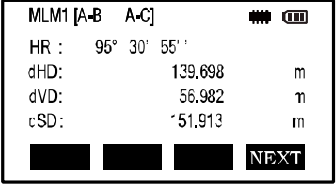
<p>⑥ Press the <b>F1</b> key</p>	<p><b>F1</b></p>	
<p>⑦ Collimate prism A, and press the <b>F1</b> (MEAS) key. Horizontal distance (HD) between the instrument and target A will be shown.</p>	<p>Collimate A <b>F1</b></p>	
<p>⑧ Press the <b>F4</b> (SET) key. The position of the target is confirmed.</p>	<p><b>F4</b></p>	
<p>⑨ Collimate prism B and press the <b>F1</b> (MEAS) key. Horizontal distance (HD) between the instrument and target B will be shown.</p>	<p>Collimate B <b>F1</b></p>	
<p>⑩ Press the <b>F4</b> (SET) key. The horizontal distance (dHD) and relative elevation (dVD) between target A and B.</p>	<p><b>F4</b></p>	

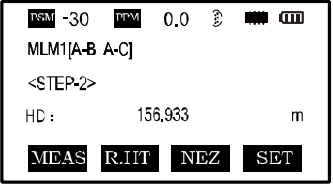
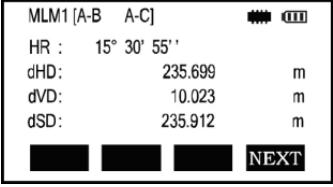

<p>(1) To measure the distance between points A and C, press the <b>F4</b> (NEXT) key*1)</p>	<p><b>F4</b></p>	
<p>(2) Collimate point C (target C) and press the <b>F1</b> (MEAS) key. Horizontal distance (HD) between the instrument and target C will be shown.</p>	<p>Collimate e C <b>F1</b></p>	
<p>(3) Press the <b>F4</b> (SET) key. The horizontal distance (dHD) and relative elevation (dvD) between target A and C will be shown.</p>	<p><b>F4</b></p>	
<p>(4) To measure the distance between points A and D, repeat procedure 12 to 14 *</p>		
<p>*To return to Previous mode , press the <b>ESC</b> key.</p>		

## HOW TO USE COORDINATE DATA

It is possible to input coordinate values directly or calculate from a coordinate data file.

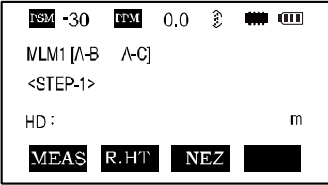
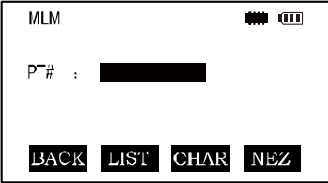
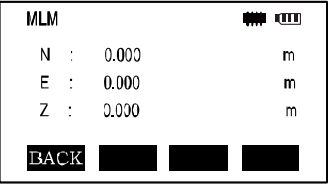
[Example] Input the data (NEZ) directly:

Operation procedure	Operation	Display
<p>① Press the <b>F3</b> (NEZ) key</p>	<p><b>F3</b></p>	 
<p>② Press the <b>F4</b> (coordinate) key</p>	<p><b>F4</b></p>	

<p>③Enter coordinate, press  <b>ENT</b> key to get to the  second point.</p>		
--	---	---

\*To return to PROGRAMS Menu, press the ESC key.

### 7.3 Area Calculation

This mode calculates the area of an enclosed figure.

There are two area calculation methods as follows:

- 1) Area calculation from Coordinate data file
- 2) Area calculation from measured data

Note:

Area is not calculated correctly if observed lines cross each other.

It is not possible to calculate area from a mix of coordinate file data and measured data.

The number of points used for calculation is not limited.

The area to be calculated shall not exceed 200000 sqm. (approx. 49 acres)

- 1) Area calculation from Coordinate data file

Operation procedure	Operatio n	Display
---------------------	---------------	---------

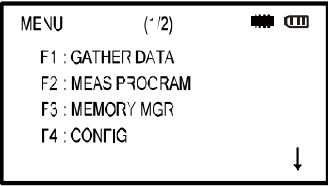
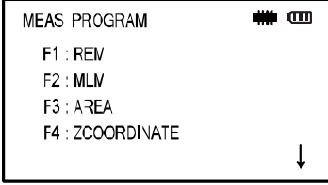
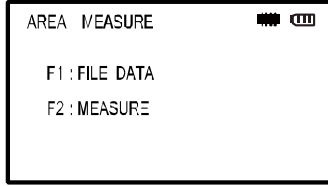
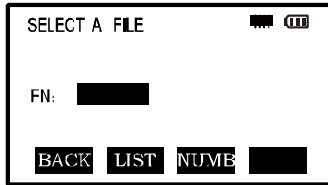
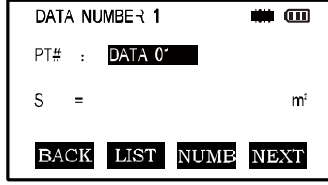
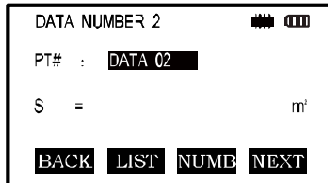

<p>① Press <b>M</b> menu key</p>	<p><b>M</b></p>	
<p>② Press the <b>F2</b> key, enter the Measurement Program.</p>	<p><b>F2</b></p>	
<p>③ Press <b>F3</b> (AREA) key</p>	<p><b>F3</b></p>	
<p>Press <b>F1</b> (FILE DATA) key</p>	<p><b>F1</b></p>	
<p>Enter file name or press F2 for LIST. Press <b>ENT</b> key, Initial display will be shown.</p>	<p>Enter File name <b>ENT</b></p>	
<p>⑥ Press <b>F4</b> (NEXT) key The top of the file data (DATA-01) will be set and the second point number</p>	<p><b>F4</b></p>	

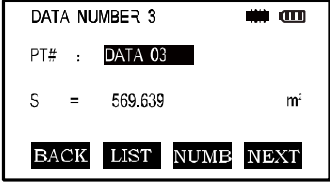

will be shown.		
Repeat pressing <b>F4</b> (NEXT) key to set required number of the points. When 3 points are set, the area surrounded by the points is calculated and the result will be shown.	<b>F4</b>	
<p>* To set the required point number, press <b>F1</b> (PT#) key.</p> <p>* To show the list of the coordinate data in the file, press <b>F2</b> (LIST) key.</p>		

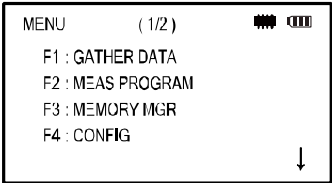
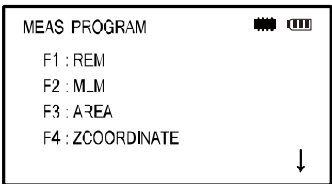
## 2) Area calculation from measured data

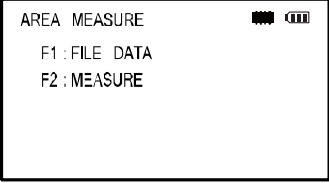
Operation procedure	Operation	Display
① Press <b>M</b> menu key	<b>M</b>	
② Press the <b>F2</b> key, enter the Measurement Program.	<b>F2</b>	

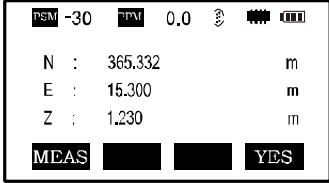
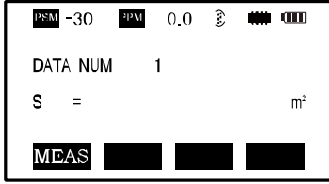
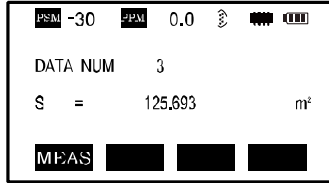
<p>③Press <b>F3</b> (AREA) key</p>	<p><b>F3</b></p>	
<p>Press the <b>F2</b> (MEASUREMENT) key</p>	<p><b>F2</b></p>	
<p>Collimate a target or prism and press the <b>F1</b> (MEAS) key. Measuring starts *</p>	<p>Collimate Prism <b>F1</b></p>	
<p>Press the <b>F4</b> key to affirm</p>	<p><b>F4</b></p>	
<p>⑦ Collimate a next prism and press <b>F1</b> (MEAS) key. When 3 points are set, the area surrounded by the points is calculated and the result will be shown.</p>	<p>Collimate <b>F1</b></p>	
<p>*1 Measurement is N-time measurement mode.</p>		

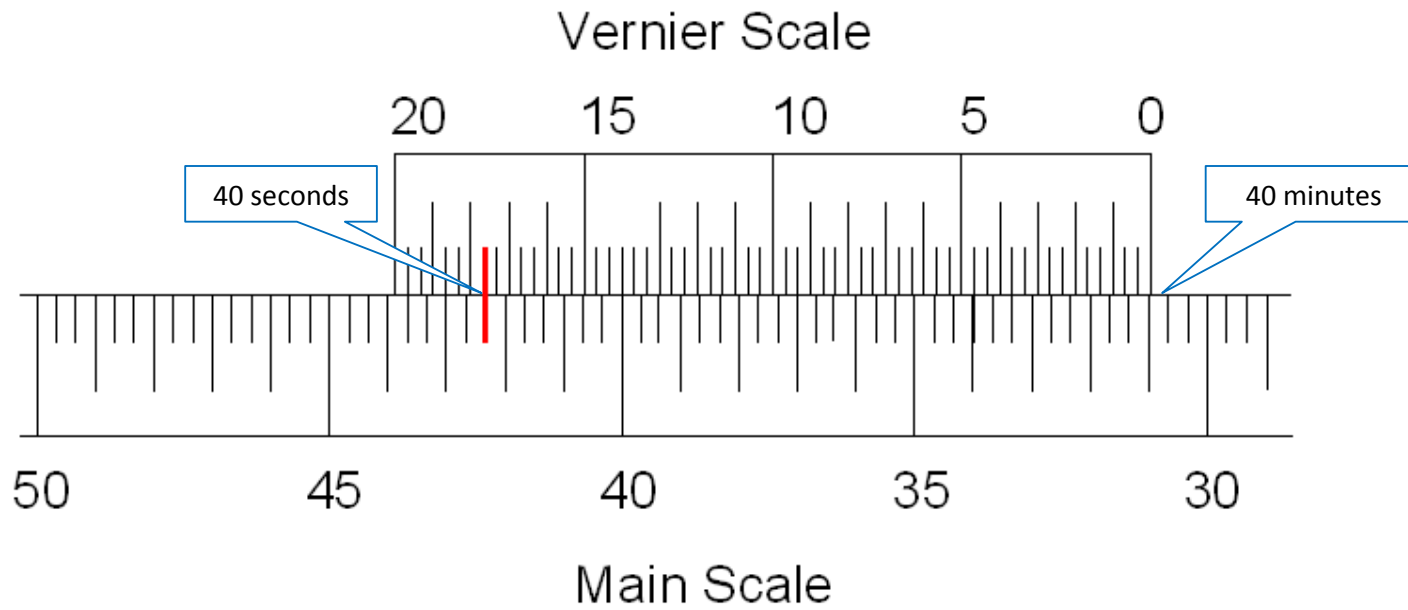

	0	'	''
Main Scale	30	40	
Vernier Scale		17	40
<b>Reading</b>	<b>30</b>	<b>57</b>	<b>40</b>

**Theodolite Surveying**  
 Measuring Horizontal Distance using **Repetition Method**

Instrument at	Sighted To	Angle	Scale - A			Scale - B		Mean Reading			Angle				
			°	'	"	'	"	°	'	"	°	'	"		
<b>Face Left</b>															
O	P	POQ	0	0	0	0	0	0	0	0					
	Q														
O	P	POQ													
	Q														
O	P	POQ													
	Q														
<b>Face Right</b>															
O	P	POQ	0	0	0	0	0	0	0	0					
	Q														
O	P	POQ													
	Q														
O	P	POQ													
	Q														
											Average Angle				





## SURVEYING LAB II

### VIVA VOCE

#### Theodolite

1. What is Theodolite?
2. Uses of Theodolite?
3. Types of Theodolite?
4. What are major components of Theodolite?
5. What is Line of Collimation?
6. What is Transiting?
7. What is Swinging of Telescope?
8. What are Face Left and Face Right?
9. What are temporary adjustments?
10. What is Parallax? How do you eliminate Parallax?
11. What is the least count of Theodolite?
12. What is the difference between Dumpy Level and Theodolite?
13. What is deflection angle? How do you measure with Theodolite?
14. List out various methods of measurement of Horizontal Angle?
15. What is Trigonometric Leveling
16. List out various problems encountered in Trigonometric Leveling?
17. Say true or false: The maximum angle that can be measured with the vertical circle is  $180^\circ$ .
18. What do you mean by "Staff held normal"?
19. What is the difference between fixed hair method and movable hair method?
20. What is the difference between staff intercept and stadia intercept?
21. What is tacheometry?
22. What are Tacheometric constants?
23. What is anallactic lens? Why it is used?
24. For finding the elevation of an inaccessible object, which survey will you recommend?

#### Curves

25. Types of Horizontal Curves?
  26. Elements of Simple Circular Curve?
  27. List out various methods used in Curve Setting?
  28. What is the degree of curve?
  29. What is the name for starting point of a curve?
-

30. What is the name for ending point of a curve?
31. What is difference between sub-chord and normal chord?
32. What do you mean by back tangent?
33. Which method is simple – Rankine's method or Double theodolite method? Justify.

### **Total Station**

34. What is Total Station?
  35. Major components of Total Station?
  36. Uses of Total Station?
  37. What is the Least of Count of Total Station?
  38. Nowadays targets are not necessary for doing surveying. Is it true?
-